

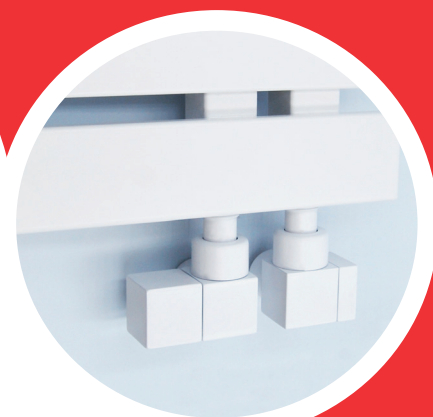

saving energy 



MANUFACTURER OF RADIATOR FITTINGS

PRODUCT CATALOG

2021/B

HISTORY OF VARIO TERM

Mera-Pnefal was the first company in Poland and one of the first in Europe manufacturing thermostatic heads. First designs of fluid sensors were created in the 1980's on the basis of bellows produced for pneumatic automation systems.

Thermostatic heads, thermostatic valves and other radiator's equipment under Mera Term brand are designed and manufactured with accordance to tradition, strict quality requirements and high technological level.



1964

Bellows for assembling control-measurement instruments



1988

First thermostatic head with a fluid sensor, Type: M615



1993

Thermostatic head with a fluid sensor, Type: M616



1999

CLASSIC thermostatic head



2004

Thermostatic heads: PLUS, TREN-DY, PRESTIGE, VENUS



2017 - 2020

Thermostatic heads: DISTANT, CONTACT and PICCO; ALL IN ONE sets, System VRC



2021

Thermostatic heads: TUCAN, PONY, ALL IN ONE GLAMOUR sets

Thanks to the **modern shape** of thermostatic heads and stainless steel of Vario Term valves, they perfectly complement radiators of different manufacturers.

Vario Term thermostatic heads and valves regulate radiators' work and as a result reduce energy consumption, improve temperature comfort of rooms and certainly are an additional element decorating a radiator.

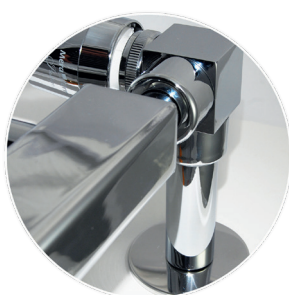

The company Vario Term was awarded the title of „Forbes Diamond 2021“.

VARIO TERM TODAY

Vario Term offers heads, thermostatic valves and other radiator equipment items and is one of the few native manufacturers and exporters of such solutions, especially exclusive fittings.

We divide our products into four basic categories. Among them, you can find both exclusive solutions and cheaper products, but still in an interesting design offer. The cheapest thermostatic or regulatory sets, without the color versions, is the Economy class. The level above includes sets with thermostatic valves equipped with presetting, with cheaper warheads, but without colors (standard class).

For more demanding users who care about the color matching of the fittings to the radiator, the Elegant sets are designed, in which most valves have a set point. The highest category of Vario Term products are Exclusive sets. There is a full range of colors available for them along with the coating of structural varnishes, individual orders for unusual colors are also possible, eg gold, pink, green etc. They are the best quality products dedicated to the most expensive decorative radiators. A full range of colors is available for them, together with a coating of structural varnishes, it is also possible to order atypical colors, eg yellow, red, etc. We will produce the **ALL IN ONE** set with color-matched fittings in any color from the RAL palette.

Vario Term offers both individual thermostatic heads and thermostatic valves as well as complete sets. We also offer mounting accessories. These are connectors, extensions, rosettes and other parts, painted in the Color of the radiator or valve. Thanks to these accessories, you can hid pipes, wall passages and other unsightly elements of the radiator connection.



In addition to the fact that radiator accessories must be interesting in design and enable precise temperature control, it is also important to be safe. Therefore, when deciding on the choice of a given product, it is worth checking if it has the appropriate safety certificates and declarations of conformity. This is a very important aspect for us and that is why, in the interest of quality and safety of our products, we have obtained a positive opinion from the WSP Lab in Stuttgart.

Thanks to the positive results of laboratory tests, we await the approval of the European Technical Assessment certificate by the Building Research Institute in Warsaw. In addition, basic thermostatic products and sets have been tested at the Institute of Power Engineering in Radom. The designs of the Vario Term thermostatic heads are registered in the Office for Harmonization in the Internal Market of OHIM as community designs and are protected.

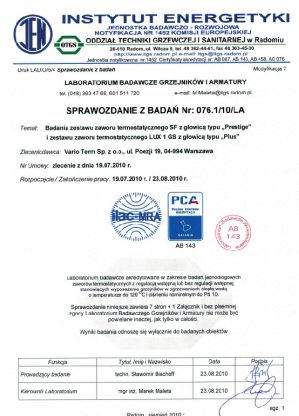

PONY THERMOSTATIC HEADS

Thermostatic head meets requirements of PN-EN 215:2005 norm

Technical data:

Range	6°C - 32°C* (16°C - 32°C)
Maximum external temperature	50°C
Closure time	16 min.
Pressure difference impact	< 1K
Hysteresis	0,3K
Heating factor temperature impact	1,23K



* LIMITING THE TEMPERATURE ADJUSTMENT RANGE

At the customer's request, the temperature regulation range can be factory limited in the range of 6°C - 16°C; 16°C - 32°C.

Application:

„Pony” thermostatic heads are modern classic radiator temperature regulators.

The use of a thermostatic head of the „Pony” series guarantees significant savings in energy consumption, and thus contributes to the reduction of household expenses. It is also a very important device increasing the comfort of everyday life - it adjusts the ambient temperature to the needs and preferences of the user.

The „Pony” heads are designed to work with most of the available thermostatic valves used with older cast iron radiators or modern C-type (compact) plate heaters, and with C-type (compact) and V-type heaters (equipped with a valve insert).

Characteristic:

- Built-in reliable liquid sensor
- Control knob with numerical marking of the settings
- System frost protection function (6°C on „*” setting)
- High-quality plastic plinth, adapted to work at elevated temperatures
- Exterior elements of the head made of ABS plastic in white
- Makes it easier to keep the Pony thermostatic head clean
- Setting the temperature setpoint is intuitive
- The head design is helpful for people with different sensory efficiency due to the characteristic „click” on the given settings

Regulation scale corresponding to the following temperature:

•	1	2	3	4	5	6
6°C	12°	16°	20°	24°C	28°	32°C

PONY THERMOSTATIC HEADS

The thermostatic head can be equipped with an anti-theft protection and temperature protection, e.g. from 16°C. In order to receive an offer, please contact the office or the Vario Term Export Department.

GS.10 (thread M30x1,5)

Color	Type	Catalog number	Price
White	GS.10-06C	000M665A001	42 zł

Designed for thermostatic valves:

- Vario Term,
- valve inserts in the Heimeier standard,
- others with the M30x1.5 standard.



The management system implemented in Vario Term to manufacturing of thermostatic heads functions according to ISO 9001:2015.

We give a 3-year warranty on thermostatic heads.



TRENDY THERMOSTATIC HEADS

Thermostatic head meets requirements of PN-EN 215:2005 norm

Technical data:

Range	8°C – 30°C* (16°C - 30°C)
Maximum external temperature	50°C
Closure time	16 min.
Pressure difference impact	< 1K
Hysteresis	0,3K
Heating factor temperature impact	1,23K



* LIMITING THE TEMPERATURE ADJUSTMENT RANGE

The temperature range regulation can be limited on customer's request according to values on setting scale. The customer can also apply it independently. In order to do so, you should screw out a blocking spare split pin with a small screw driver on set no. 6, which is situated in a slot no. 0 and place it in another slot, for example no. 4 for maximum temperature of 24°C, etc. To decrease a minimum temperature in a room to 16°C, you should place a blocking split pin in a slot no. 2 and set the head on no. 2. In GS.04 and GHe.01 thermostatic heads a temperature can be limited only to 8°C to 16°C



Application:

The „Trendy“ thermostatic head is a radiator temperature controller with an economical design. It allows you to maintain the desired thermal comfort in the room while taking into account heat gains from other sources, such as heat gain from people, lighting, and sun exposure.

Due to its design, it guarantees easy cleaning, which makes it irreplaceable in hospital, sanatorium, school, etc.

Characteristics:

- Reliable fluid sensor
- Regulating knob with digital marking
- Protection from freezing function (8°C on a setting marked with *)
- Base made of high quality plastic, adjusted to work in higher temperature
- Nice-looking main body and knob made of white ABS plastic
- Availability of limiting minimum as well as maximum temperature

Regulation scale corresponding to the following temperature:

•	1	2	3	4	5	6
8°C	12°	16°	20°	24°C	28°	30°C

TRENDY THERMOSTATIC HEADS

The thermostatic head can be equipped with an anti-theft protection and temperature protection, e.g. from 16°C. In order to receive an offer, please contact the office or the Vario Term Export Department.

GS.05 (thread M30x1,5)

Color	Type	Catalog number	Price
White	GS.05-106C	000M651A101	38 zł

Designed for thermostatic valves by Vario Term, Heimeier and others (M30x1,5 connecting thread), inserts of Heimeier standard.

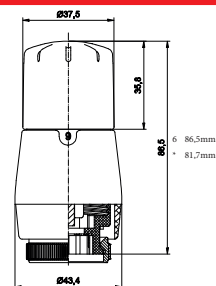

GS.06 (standard RTD)

Color	Type	Catalog number	Price
White	GS.06-106C	000M652A101	38 zł

Designed for thermostatic valves and inserts by Danfoss in the RTD standard.

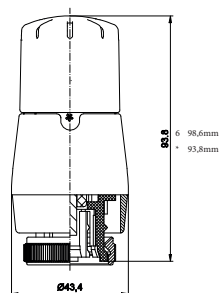

GS.07 (standard Click)

Color	Type	Catalog number	Price
White	GS.07-306C	000M653A301	41 zł

Designed for valve inserts Oventrop, Danfoss, Brugman, Perfexim with RA connection and thermostatic valves Danfoss (click).

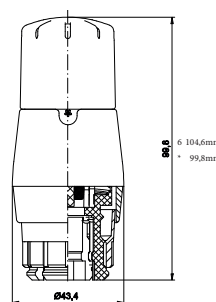

GS.08 (standard Vario)

Color	Type	Catalog number	Price
White	GS.08-106C	000M654A101	38 zł

Designed for valve inserts Jafar, Valvex, Jan-K, thermostatic valves by Vario Term VFP and VFK, Mera Pniefal since 1995.

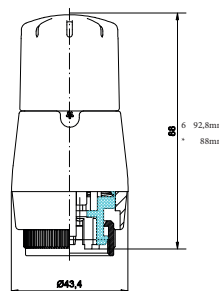

GHe.02 (thread M28x1,5)

Color	Type	Catalog number	Price
White	GHe.02-106C	000M655A101	38 zł

Designed for thermostatic valves by Herz and inserts with thread M28x1,5.

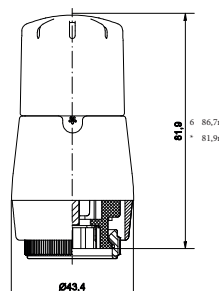

VENUS THERMOSTATIC HEADS

Thermostatic head meets requirements of PN-EN 215:2005 norm

Technical data:

Range	8°C – 30°C* (16°C – 30°C)
Maximum external temperature	50°C
Closure time	16 min.
Pressure difference impact	< 1K
Hysteresis	0,3K
Heating factor temperature impact	1,23K



* LIMITING THE TEMPERATURE ADJUSTMENT RANGE

The temperature range regulation can be limited on customer's request according to values on setting scale. The customer can also apply it independently. In order to do so, you should screw out a blocking spare split pin with a small screw driver on set no. 6, which is situated in a slot no. 0 and place it in another slot, for example no. 4 for maximum temperature of 24°C, etc. To decrease a minimum temperature in a room to 16°C, you should place a blocking split pin in a slot no. 2 and set the head on no. 2. In GS.04 and GHe.01 thermostatic heads a temperature can be limited only to 8°C to 16°C and from 16°C to 30°C.



Application:

The „Venus“ thermostatic head is a radiator temperature controller with an economical design. It allows you to maintain the desired thermal comfort in the room while taking into account heat gains from other sources, such as heat gain from people, lighting, and sun exposure.

Due to its design, it guarantees easy cleaning, which makes it irreplaceable in hospital, sanatorium, school, etc.

Characteristics:

- Reliable fluid sensor
- Regulating knob with digital marking
- Protection from freezing function (8°C on a setting marked with *)
- Main body made of high quality plastic and aluminum

Regulation scale corresponding to the following temperature:

•	1	2	3	4	5	6
8°C	12°	16°	20°	24°C	28°	30°C

VENUS THERMOSTATIC HEADS

The thermostatic head can be equipped with an anti-theft protection and temperature protection, e.g. from 16°C. In order to receive an offer, please contact the office or the Vario Term Export Department.

VENUS I (thread M30x1,5)

Color	Type	Catalog number	Price
White-Chrome	GS.09-01C	000M642A001	46 zł
Chrome	GS.09-02C	000M642A002	93 zł
White	GS.09-06C	000M642A006	45 zł

Designed for thermostatic valves by Vario Term, Heimeier and others (M30x1,5 connecting thread, inserts of Heimeier standard).

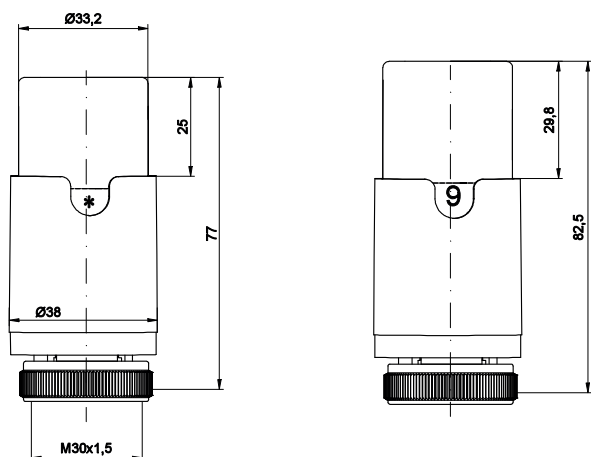

VENUS II (thread M30x1,5)

Color	Type	Catalog number	Price
White-Chrome	GS.09-101C	000M642A101	46 zł
Chrome	GS.09-102C	000M642A102	93 zł
White	GS.09-106C	000M642A106	45 zł

Designed for thermostatic valves by Vario Term, Heimeier and others (M30x1,5 connecting thread, inserts of Heimeier standard).

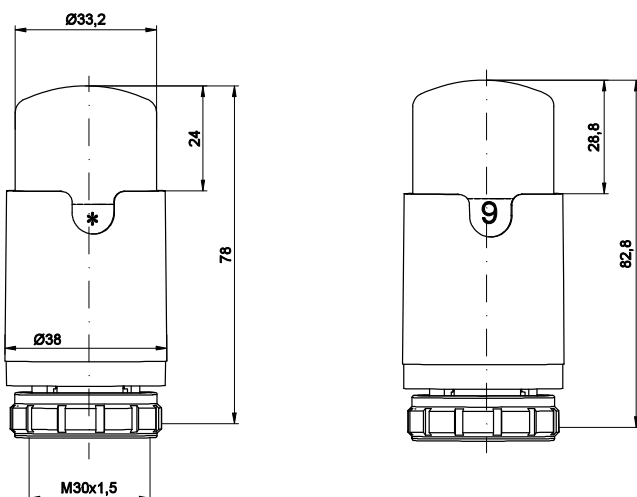

We give a 3-year warranty on thermostatic heads.

PICCO THERMOSTATIC HEADS

Thermostatic head meets requirements of PN-EN 215:2005 norm

Technical data:

Range	8°C – 30°C* (16°C - 30°C)
Maximum external temperature	50°C
Closure time	16 min.
Pressure difference impact	< 1K
Hysteresis	0,3K
Heating factor temperature impact	1,23K



* LIMITING THE TEMPERATURE ADJUSTMENT RANGE

At the customer's request, the temperature regulation range can be factory limited according to the values given on the setting scale. This activity can also be performed by the customer on his own. To change the maximum temperature of the head, with the setting „*“, use a small flat-head screwdriver to remove the spare locking pin embedded in the hole with the number „0“ and insert it in another hole, e.g. with the number „5“ for a maximum temperature of 24°C (working range of the head from „*“ to „4“). To change the minimum temperature in the room from 16°C, set the head to the setting „6“, and then, using a small flat screwdriver, remove the spare locking pin embedded in the hole number „0“ and insert it into the hole number „2“ - the working range of the head from „2“ to „6“.



Application:

The „Picco“ thermostatic head is a radiator temperature controller with an economical design. It allows you to maintain the desired thermal comfort in the room while taking into account heat gains from other sources, such as heat gain from people, lighting, and sun exposure.

Due to its design, it guarantees easy cleaning, which makes it irreplaceable in hospital, sanatorium, school, etc.

Characteristics:

- Reliable fluid sensor
- Regulating knob with digital marking
- Protection from freezing function (8°C on a setting marked with *)
- Main body made of high quality plastic and aluminum

Regulation scale corresponding to the following temperature:

•	1	2	3	4	5	6
8°C	12°	16°	20°	24°C	28°	30°C

PICCO THERMOSTATIC HEADS

The thermostatic head can be equipped with an anti-theft protection and temperature protection, e.g. from 16°C. In order to receive an offer, please contact the Vario Term Export Department.

GS.02 (thread M30x1,5)



Designed for thermostatic valves by Vario Term, Heimeier and others (M30x1,5 connecting thread), inserts of Heimeier standard.

No.	Color	Type	Catalog number	Price
01	White-Chrome	GS.02-101P	000M660A101	58 zł
02	Chrome	GS.02-102P	000M660A102	100 zł
03	Satin	GS.02-103P	000M660A103	111 zł
04	Gold	GS.02-104P	000M660A104	106 zł
05	Structural graphite	GS.02-105P	000M660A105	106 zł
06	White	GS.02-106P	000M660A106	58 zł
07	Glossy anth./Graph.	GS.02-107P	000M660A107	106 zł
08	Nickel-grinded	GS.02-108P	000M660A108	111 zł
09	Sand structural	GS.02-109P	000M660A109	106 zł
10	Dark sand structural	GS.02-110P	000M660A110	106 zł
11	Antique brass	GS.02-111P	000M660A111	111 zł
12	Metallic graphite	GS.02-112P	000M660A112	106 zł
13	Glossy black	GS.02-113P	000M660A113	106 zł
14	Structural black	GS.02-114P	000M660A114	106 zł
15	Dark str. graphite	GS.02-115P	000M660A115	106 zł
16	Structural maroon	GS.02-116P	000M660A116	106 zł
17	Gray metallic	GS.02-117P	000M660A117	106 zł
18	Granite	GS.02-118P	000M660A118	106 zł
19	Structural white	GS.02-119P	000M660A119	106 zł
21	Matt white	GS.02-121P	000M660A121	106 zł
24	Matt black	GS.02-124P	000M660A124	106 zł



PICCO THERMOSTATIC HEADS

The thermostatic head can be equipped with an anti-theft protection and temperature protection, e.g. from 16°C. In order to receive an offer, please contact the Vario Term Export Department.

GS.03 (standard RTD)



Designed for Danfoss RTD valves and RTD thermostatic inserts.

No.	Color	Type	Catalog number	Price
01	White-Chrome	GS.03-101P	000M661A101	58 zł
02	Chrome	GS.03-102P	000M661A102	100 zł
03	Satin	GS.03-103P	000M661A103	111 zł
04	Gold	GS.03-104P	000M661A104	106 zł
05	Structural graphite	GS.03-105P	000M661A105	106 zł
06	White	GS.03-106P	000M661A106	58 zł
07	Glossy anth./Graph.	GS.03-107P	000M661A107	106 zł
08	Nickel-grinded	GS.03-108P	000M661A108	111 zł
09	Sand structural	GS.03-109P	000M661A109	106 zł
10	Dark sand structural	GS.03-110P	000M661A110	106 zł
11	Antique brass	GS.03-111P	000M661A111	111 zł
12	Metallic graphite	GS.03-112P	000M661A112	106 zł
13	Glossy black	GS.03-113P	000M661A113	106 zł
14	Structural black	GS.03-114P	000M661A114	106 zł
15	Dark str. graphite	GS.03-115P	000M661A115	106 zł
16	Structural maroon	GS.03-116P	000M661A116	106 zł
17	Gray metallic	GS.03-117P	000M661A117	106 zł
18	Granite	GS.03-118P	000M661A118	106 zł
19	Structural white	GS.03-119P	000M661A119	106 zł
21	Matt white	GS.03-121P	000M661A121	106 zł
24	Matt black	GS.03-124P	000M661A124	106 zł



PICCO THERMOSTATIC HEADS

The thermostatic head can be equipped with an anti-theft protection and temperature protection, e.g. from 16°C. In order to receive an offer, please contact the Vario Term Export Department.

GS.04 (standard Click, RA-N)



Designed for Click valve inserts from: Oventrop, Danfoss, Brugman and Danfoss RA-N (Click) thermostatic valves.

No.	Color	Type	Catalog number	Price
01	White-Chrome	GS.04-101P	000M662A101	66 zł
02	Chrome	GS.04-102P	000M662A102	113 zł
03	Satin	GS.04-103P	000M662A103	126 zł
04	Gold	GS.04-104P	000M662A104	120 zł
05	Structural graphite	GS.04-105P	000M662A105	120 zł
06	White	GS.04-106P	000M662A106	66 zł
07	Glossy anth./Graph.	GS.04-107P	000M662A107	120 zł
08	Nickel-grinded	GS.04-108P	000M662A108	126 zł
09	Sand structural	GS.04-109P	000M662A109	120 zł
10	Dark sand structural	GS.04-110P	000M662A110	120 zł
11	Antique brass	GS.04-111P	000M662A111	126 zł
12	Metallic graphite	GS.04-112P	000M662A112	120 zł
13	Glossy black	GS.04-113P	000M662A113	120 zł
14	Structural black	GS.04-114P	000M662A114	120 zł
15	Dark str. graphite	GS.04-115P	000M662A115	120 zł
16	Structural maroon	GS.04-116P	000M662A116	120 zł
17	Gray metallic	GS.04-117P	000M662A117	120 zł
18	Granite	GS.04-118P	000M662A118	120 zł
19	Structural white	GS.04-119P	000M662A119	120 zł
21	Matt white	GS.04-121P	000M662A121	120 zł
24	Matt black	GS.04-124P	000M662A124	120 zł



We give a 3-year warranty on thermostatic heads.

PRESTIGE THERMOSTATIC HEADS

Thermostatic head meets requirements of PN-EN 215:2005 norm

Technical data:

Range	8°C – 30°C* (16°C - 30°C)
Maximum external temperature	50°C
Closure time	16 min.
Pressure difference impact	< 1K
Hysteresis	0,3K
Heating factor temperature impact	1,23K



* LIMITING THE TEMPERATURE ADJUSTMENT RANGE

The temperature range regulation can be limited on customer's request according to values on setting scale. The customer can also apply it independently. In order to do so, you should screw out a blocking spare split pin with a small screw driver on set no. 6, which is situated in a slot no. 0 and place it in another slot, for example no. 4 for maximum temperature of 24°C, etc. To decrease a minimum temperature in a room to 16°C, you should place a blocking split pin in a slot no. 2 and set the head on no. 2. In GS.04 and GHe.01 thermostatic heads a temperature can be limited only to 8°C to 16°C and from 16°C to 30°C.



Application:

The „Prestige” thermostatic head is a radiator temperature controller with an economical design. It allows you to maintain the desired thermal comfort in the room while taking into account heat gains from other sources, such as heat gain from people, lighting, and sun exposure.

Due to its design, it guarantees easy cleaning, which makes it irreplaceable in hospital, sanatorium, school, etc.

Characteristics:

- Reliable fluid sensor
- Regulating knob with digital marking
- Protection from freezing function (8°C on a setting marked with *)
- Main body made of high quality plastic and aluminum

Regulation scale corresponding to the following temperature:

•	1	2	3	4	5	6
8°C	12°	16°	20°	24°C	28°	30°C

PRESTIGE THERMOSTATIC HEADS

The thermostatic head can be equipped with an anti-theft protection and temperature protection, e.g. from 16°C. In order to receive an offer, please contact the Vario Term Export Department.

GS.02 (thread M30x1,5)



Designed for thermostatic valves by Vario Term, Heimeier and others (M30x1,5 connecting thread), inserts of Heimeier standard.

No.	Color	Type	Catalog number	Price
01	White-Chrome	GS.02-01C	000M636A001	46 zł
02	Chrome	GS.02-02C	000M636A002	87 zł
03	Satin	GS.02-03C	000M636A003	99 zł
04	Gold	GS.02-04C	000M636A004	93 zł
05	Structural graphite	GS.02-05C	000M636A005	93 zł
06	White	GS.02-06C	000M636A006	45 zł
07	Glossy anth./Graph.	GS.02-07C	000M636A007	93 zł
08	Nickel-grinded	GS.02-08C	000M636A008	99 zł
09	Sand structural	GS.02-09C	000M636A009	93 zł
10	Dark sand structural	GS.02-10C	000M636A010	93 zł
11	Antique brass	GS.02-11C	000M636A011	99 zł
12	Metallic graphite	GS.02-12C	000M636A012	93 zł
13	Glossy black	GS.02-13C	000M636A013	93 zł
14	Structural black	GS.02-14C	000M636A014	93 zł
15	Dark str. graphite	GS.02-15C	000M636A015	93 zł
16	Structural maroon	GS.02-16C	000M636A016	93 zł
17	Gray metallic	GS.02-17C	000M636A017	93 zł
18	Granite	GS.02-18C	000M636A018	93 zł
19	Structural white	GS.02-19C	000M636A019	93 zł
21	Matt white	GS.02-21C	000M636A021	93 zł
24	Matt black	GS.02-24C	000M636A024	93 zł



We give a 3-year warranty on thermostatic heads.

PRESTIGE THERMOSTATIC HEADS

The thermostatic head can be equipped with an anti-theft protection and temperature protection, e.g. from 16°C. In order to receive an offer, please contact the Vario Term Export Department.

GS.03 (standard RTD)



Designed for thermostatic valves and inserts by Danfoss in the RTD standard.

No.	Color	Type	Catalog number	Price
01	White-Chrome	GS.03-01C	000M637A001	46 zł
02	Chrome	GS.03-02C	000M637A002	87 zł
03	Satin	GS.03-03C	000M637A003	99 zł
04	Gold	GS.03-04C	000M637A004	93 zł
05	Structural graphite	GS.03-05C	000M637A005	93 zł
06	White	GS.03-06C	000M637A006	45 zł
07	Glossy anth./Graph.	GS.03-07C	000M637A007	93 zł
08	Nickel-grinded	GS.03-08C	000M637A008	99 zł
09	Sand structural	GS.03-09C	000M637A009	93 zł
10	Dark sand structural	GS.03-10C	000M637A010	93 zł
11	Antique brass	GS.03-11C	000M637A011	99 zł
12	Metallic graphite	GS.03-12C	000M637A012	93 zł
13	Glossy black	GS.03-13C	000M637A013	93 zł
14	Structural black	GS.03-14C	000M637A014	93 zł
15	Dark str. graphite	GS.03-15C	000M637A015	93 zł
16	Structural maroon	GS.03-16C	000M637A016	93 zł
17	Gray metallic	GS.03-17C	000M637A017	93 zł
18	Granite	GS.03-18C	000M637A018	93 zł
19	Structural white	GS.03-19C	000M637A019	93 zł
21	Matt white	GS.03-21C	000M637A021	93 zł
24	Matt black	GS.03-24C	000M637A024	93 zł



PRESTIGE THERMOSTATIC HEADS

The thermostatic head can be equipped with an anti-theft protection and temperature protection, e.g. from 16°C. In order to receive an offer, please contact the Vario Term Export Department.

GS.04 (standard Click, RA-N)



Designed for valve inserts Oventrop, Danfoss, Brugman, Perfexim with RA connection and thermostatic valves Danfoss (click).

No.	Color	Type	Catalog number	Price
01	White-Chrome	GS.04-101C	000M638A101	52 zł
02	Chrome	GS.04-102C	000M638A102	98 zł
03	Satin	GS.04-103C	000M638A103	112 zł
04	Gold	GS.04-104C	000M638A104	106 zł
05	Structural graphite	GS.04-105C	000M638A105	106 zł
06	White	GS.04-106C	000M638A106	51 zł
07	Glossy anth./Graph.	GS.04-107C	000M638A107	106 zł
08	Nickel-grinded	GS.04-108C	000M638A108	112 zł
09	Sand structural	GS.04-109C	000M638A109	106 zł
10	Dark sand structural	GS.04-110C	000M638A110	106 zł
11	Antique brass	GS.04-111C	000M638A111	112 zł
12	Metallic graphite	GS.04-112C	000M638A112	106 zł
13	Glossy black	GS.04-113C	000M638A113	106 zł
14	Structural black	GS.04-114C	000M638A114	106 zł
15	Dark str. graphite	GS.04-115C	000M638A115	106 zł
16	Structural maroon	GS.04-116C	000M638A116	106 zł
17	Gray metallic	GS.04-117C	000M638A117	106 zł
18	Granite	GS.04-118C	000M638A118	106 zł
19	Structural white	GS.04-119C	000M638A119	106 zł
21	Matt white	GS.04-121C	000M638A121	106 zł
24	Matt black	GS.04-124C	000M638A124	106 zł



We give a 3-year warranty on thermostatic heads.

PRESTIGE THERMOSTATIC HEADS

The thermostatic head can be equipped with an anti-theft protection and temperature protection, e.g. from 16°C. In order to receive an offer, please contact the Vario Term Export Department.

GHe.01 (thread M28x1,5)



Designed for thermostatic valves by Herz and inserts with thread M28x1,5.

No.	Color	Type	Catalog number	Price
01	White-Chrome	GHe.01-01C	000M641A001	46 zł
02	Chrome	GHe.01-02C	000M641A002	87 zł
03	Satin	GHe.01-03C	000M641A003	99 zł
04	Gold	GHe.01-04C	000M641A004	93 zł
05	Structural graphite	GHe.01-05C	000M641A005	93 zł
06	White	GHe.01-06C	000M641A006	45 zł
07	Glossy anth./Graph.	GHe.01-07C	000M641A007	93 zł
08	Nickel-grinded	GHe.01-08C	000M641A008	99 zł
09	Sand structural	GHe.01-09C	000M641A009	93 zł
10	Dark sand structural	GHe.01-10C	000M641A010	93 zł
11	Antique brass	GHe.01-11C	000M641A011	99 zł
12	Metallic graphite	GHe.01-12C	000M641A012	93 zł
13	Glossy black	GHe.01-13C	000M641A013	93 zł
14	Structural black	GHe.01-14C	000M641A014	93 zł
15	Dark str. graphite	GHe.01-15C	000M641A015	93 zł
16	Structural maroon	GHe.01-16C	000M641A016	93 zł
17	Gray metallic	GHe.01-17C	000M641A017	93 zł
18	Granite	GHe.01-18C	000M641A018	93 zł
19	Structural white	GHe.01-19C	000M641A019	93 zł
21	Matt white	GHe.01-21C	000M641A021	93 zł
24	Matt black	GHe.01-24C	000M641A024	93 zł



COLOR

We are able to manufacture our heads and valves
in virtually any color version

Currently on the sanitary installation market there are more and more
color variations of decorative radiators

We strive to be flexible to meet the expectations of our clients

We are constantly looking for new shapes
and colors for our products



WE PAINT IN THE COLOR OF YOUR RADIATOR

TUCAN THERMOSTATIC HEADS

Thermostatic head meets requirements of PN-EN 215:2005 norm

Technical data:

Range	6°C – 32°C* (16°C – 32°C)
Maximum external temperature	50°C
Closure time	16 min.
Pressure difference impact	< 1K
Hysteresis	0,3K
Heating factor temperature impact	1,23K



* LIMITING THE TEMPERATURE ADJUSTMENT RANGE

At the customer's request, the temperature regulation range can be factory limited in the range of 6°C - 16°C; 16°C - 32°C.

Application:

The „Tucan” thermostatic head is a heater temperature controller with a modern, ergonomic shape. It allows you to maintain the desired thermal comfort in the room while taking into account heat gains from other sources, e.g. heat gain from people, lighting, sunlight.

Due to its design, it is easy to keep clean, which makes it irreplaceable in rooms, etc.

Characteristics:

- Reliable liquid sensor
- Control knob with numerical marking
- System frost protection function (6°C on „*” setting)
- Body made of high-quality plastic
- Facilitating the cleanliness of the „Tucan” thermostatic head
- Setting the temperature setpoint is intuitive
- The head design is helpful for people with different sensory performance due to the a characteristic „click” on the given settings

Regulation scale corresponding to the following temperature:

•	1	2	3	4	5	6
6°C	12°	16°	20°	24°C	28°	32°C

TUCAN THERMOSTATIC HEADS

The thermostatic head can be equipped with an anti-theft protection and temperature protection, e.g. from 16°C. In order to receive an offer, please contact the Vario Term Export Department.

GS.10 (thread M30x1,5)



Designed for thermostatic valves of the following companies: Vario Term, Heimeier and others (thread M30x1,5 - valve inserts in Heimeier standard).

No.	Color	Type	Catalog number	Price
01	White-Chrome	GS.10-101C	000M665A101	112 zł
02	Chrome	GS.10-102C	000M665A102	112 zł
03	Satin	GS.10-103C	000M665A103	119 zł
04	Gold	GS.10-104C	000M665A104	112 zł
05	Structural graphite	GS.10-105C	000M665A105	112 zł
06	White	GS.10-106C	000M665A106	112 zł
07	Glossy anth./Graph.	GS.10-107C	000M665A107	112 zł
08	Nickel-grinded	GS.10-108C	000M665A108	119 zł
09	Sand structural	GS.10-109C	000M665A109	112 zł
10	Dark sand structural	GS.10-110C	000M665A110	112 zł
11	Antique brass	GS.10-111C	000M665A111	119 zł
12	Metallic graphite	GS.10-112C	000M665A112	112 zł
13	Glossy black	GS.10-113C	000M665A113	112 zł
14	Structural black	GS.10-114C	000M665A114	112 zł
15	Dark str. graphite	GS.10-115C	000M665A115	112 zł
16	Structural maroon	GS.10-116C	000M665A116	112 zł
17	Gray metallic	GS.10-117C	000M665A117	112 zł
18	Granite	GS.10-118C	000M665A118	112 zł
19	Structural white	GS.10-119C	000M665A119	112 zł
21	Matt white	GS.10-121C	000M665A121	112 zł
24	Matt black	GS.10-124C	000M665A124	112 zł

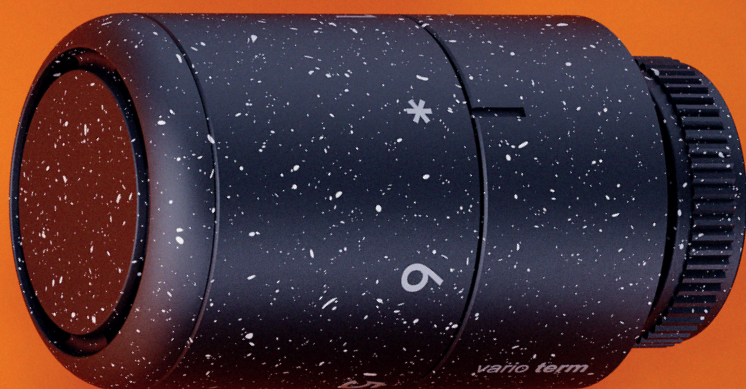

We give a 3-year warranty on thermostatic heads.

HEADS WITH A FORGING SENSOR

Thermostatic head Contact



The CONTACT thermostatic head is designed for cooperation with radiator valves and valve inserts with M30x1,5 connection. The temperature measurement element (sensor) is located outside the regulating part, and their connection is made through a special capillary.

Thermostatic head Contact is used for underfloor heating.

Color	Catalog number	Price
White	000M657A006	143 zł

Technical data:

Range	25°C – 70°C
Closure time	16 min.
Pressure difference impact	< 1K
The length of the capillary	2 meters

Application:

The CONTACT thermostatic head is a radiator temperature controller used to control the temperature of tap water, constant temperature control in the case of integrated underfloor heating systems and in air heating systems as an air temperature regulator. In the case of the use of the CONTACT type head in integrated floor heating systems, the size of the heated surface depends on the thermostatic valve and the size of its flow.

The temperature measurement element (sensor) is located outside the regulating part, and their connection is made through a special capillary.

The CONTACT thermostatic head is designed for cooperation with radiator valves and valve inserts with M30x1,5 connection.

Assembly:

In order to ensure correct operation, the temperature measuring element (sensor) of the head should be mounted together with the luminaire, which has a high coefficient of conductivity, to the pipelines with clamps to ensure proper heat transfer.

All installation operations are carried out with the head set to the „70” setting.

The thermostatic head can be equipped with an anti-theft protection and temperature protection, e.g. from 16°C. In order to receive an offer, please contact the Vario Term Export Department.

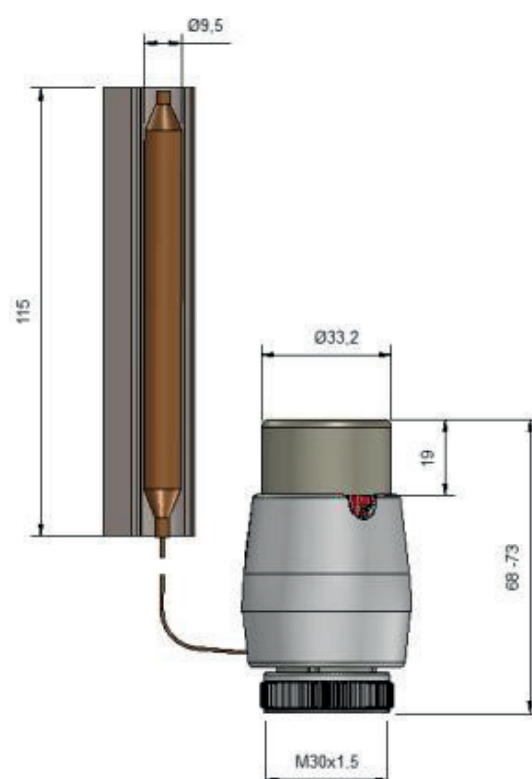

HEADS WITH SENSOR REMOVE

Thermostatic head Distant

The DISTANT thermostatic head is designed for cooperation with radiator valves and valve inserts with M30x1,5 connection. The temperature measurement element (sensor) is located outside the regulating part, and their connection is made through a special capillary.



Color	Catalog number	Price
White	000M658A006	138 zł

Technical data:

Range	8°C – 30°C
Maximum external temperature	50°C
Closure time	16 min.
Pressure difference impact	< 1K
The length of the capillary	2 meters

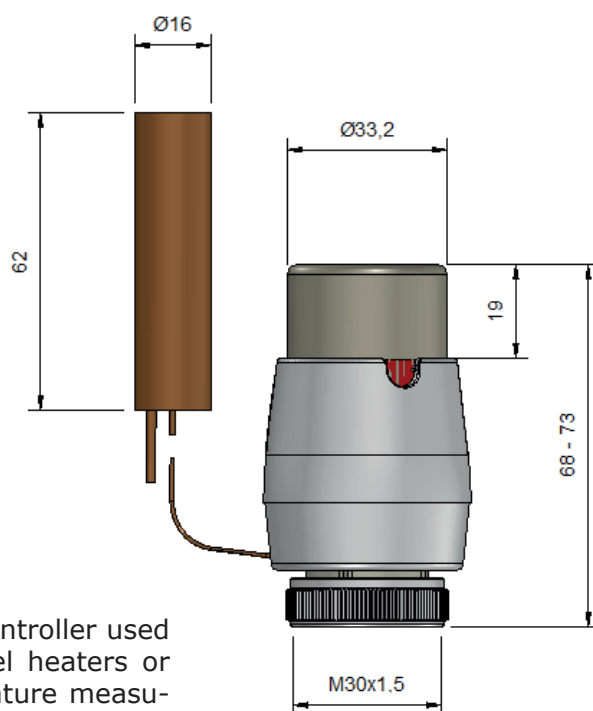

Application:

The DISTANT thermostatic head is a radiator temperature controller used to control the temperature of rooms equipped with channel heaters or when the heating device is built-in or covered. The temperature measurement element (sensor) is located outside the regulating part, and their connection is made through a special capillary.

The DISTANT thermostatic head is designed for cooperation with radiator valves and valve inserts with M30x1,5 connection.

Assembly:

In order to ensure correct operation, the temperature measurement element (sensor) of the head should be mounted on the interior wall of the room in such a way as to allow free air flow around the sensor.

The head is mounted in a vertical position, and all installation operations are carried out with the head set to the „6” setting.

Recommendations:

After the heating season, it is recommended to set the thermostatic head to the „6” setting.

Regulation scale corresponding to the following temperature:

•	1	2	3	4	5	6
8°C	12°	16°	20°	24°C	28°	30°C

THERMOSTATIC VALVES

Technical data	
Work temperature	max 120°C
Working pressure	max 10 bar
Pressure difference	0,06 MPa
Assembly thread	M30x1,5

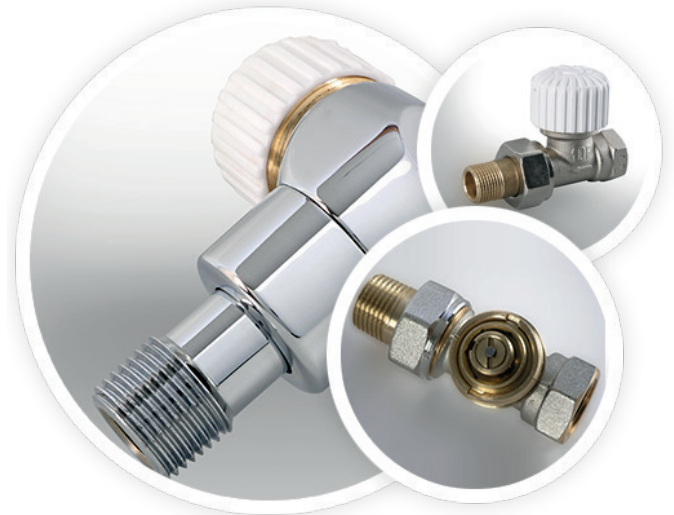

Application:

Thermostatic valves SFP15 (straight) and SFK15 (angular) are designed for installation in central heating systems with forced heating factor circuit which temperature should not exceed 393K (120°C) and pressure differences should not exceed 0.06 MPa.

Basic design features:

The valve has 8 regulating flow settings marked on the setting ring (key KN-01) with numbers from 1 to 7 and letters PP (full flow). There is a possibility of so called between settings, which are between the numbers 1-7. The setting can be changed when a suitable number on the key is set towards a sign (groove) on the main body of the valve.

Sizes according to PN-EN 215 Annex A (Table A.2 - Series F)

Additional accessories:

1. DM-03 "Demoblock" - a dismantling tool for valves
2. PZ-01 sealing for thermostatic head
3. PZ-03 sealing - protects from changing an initial setting in the valve
4. Setting key KN-01

The management system operating in Vario Term in the production of thermostatic heads is compliant with ISO 9001 and is certified by a SGS certificate.

We give a 3-year warranty on thermostatic heads.

THERMOSTATIC VALVES

The initial setting and the corresponding values of KV flow coefficients

For SFP15 / SFK15 (Kv [m³/h] – calculation (nominal) flow factor)

PP - full flow

All valves have 8 pre-set flow adjustments.

It is possible to order special screw connections, longer than the nominal value by 5, 10 and 15 mm (important when renovating old installations).

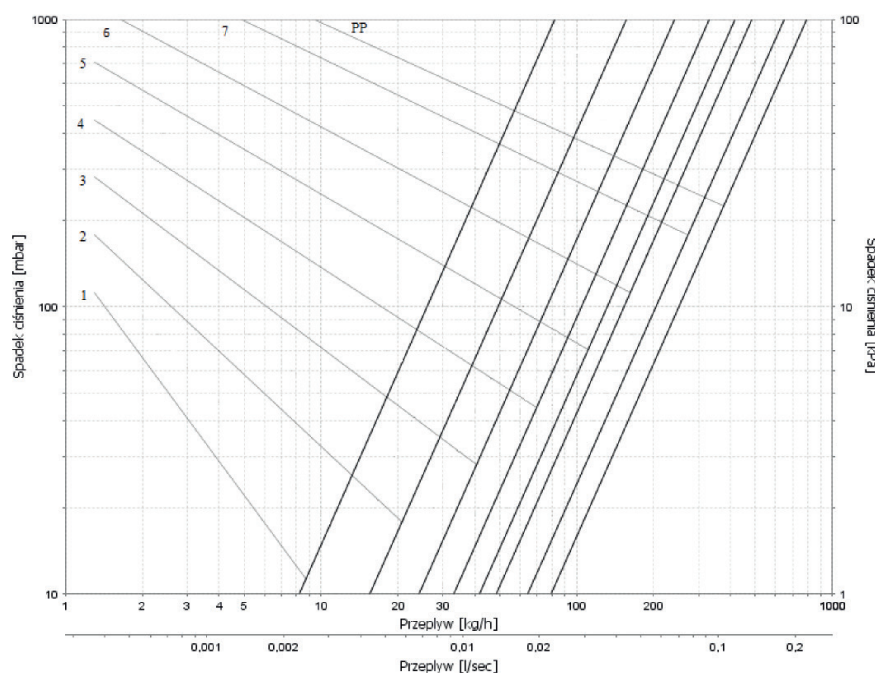

Initial setting

Setting	1	2	3	4	5	6	7	PP
Kv	0,08	0,15	0,24	0,32	0,41	0,48	0,64	0,79
Tolerance	±10%							

For SFP10 (Kv [m³/h] – calculation (nominal) flow factor)

Initial setting

Setting	1	2	3	4	5	6	7	PP
Kv	0,04	0,08	0,11	0,14	0,18	0,24	0,44	0,58
Tolerance	±10%							

Max. permissible temperature of heating water	393K (120°C)
Hysteresis	0,3K
Pressure difference impact	< 1K
Heating water temperature impact	1,23K
Closure time	16 min.
Thermostatic head's resistance to overheating	313K (40°C)
Transportation temperature	253 K ÷ 313 K (-20° ÷ +40°C)

RADIATOR VALVES

SFP15 / SFK15, 1/2"x1/2"

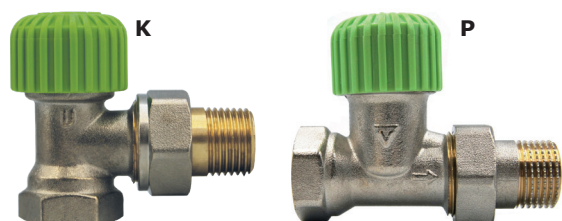

Color	Type	Catalog number	Price
Nickel	Straight	000M751A001	51 zł
Nickel	Angular	000M752A001	51 zł

Straight „SFP 15” or angular „SFK 15” thermostatic valve bodies. GW 1/2” / GZ 1/2”, mounting thread M30x1,5. It has a valve setting ring.

SFP / SFK (na PEX lub Cu), 1/2"x3/4"

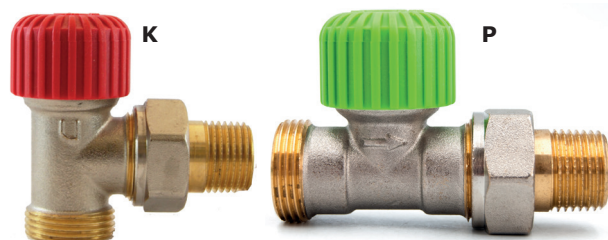

Color	Type	Catalog number	Price
Nickel	Straight	000M755A001	50 zł
Nickel	Angular	000M756A001	50 zł

Straight „SFP” or angular „SFK” thermostatic valve bodies. GZ 1/2” / GZ 3/4”, mounting thread M30x1,5. It has an output for PEX / Cu adapters (connectors are not included in the price of the valve). It has a valve setting ring.



SFP10, 3/8"x3/8"

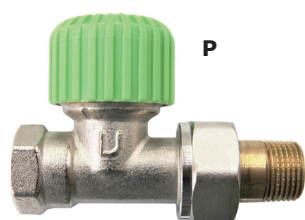

Color	Type	Catalog number	Price
Nickel	Straight	000M749A001	51 zł

Straight thermostatic valve „SFP10”, economical, mounting thread M30x1.5. GW 3/8” / GZ 3/8”. Without pre-setting.



EFP / EFK, 1/2"x1/2"

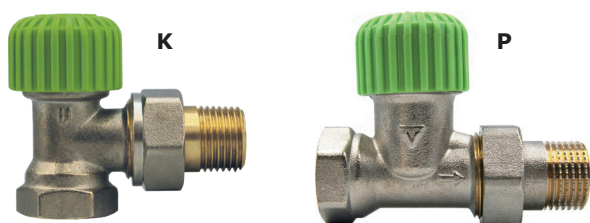

Color	Type	Catalog number	Price
Nickel	Straight	000M753A001	41 zł
Nickel	Angular	000M754A001	41 zł

Angular thermostatic valve „EFK” or straight „EFP”, economical, mounting thread M30x1.5. GW 1/2” / GZ 1/2”. Without pre-setting.



ARCUS, 1/2"x1/2"



Color	Type	Catalog number	Price
Nickel	Left	000M772A101	55 zł
Nickel	Right	000M773A101	55 zł

Arcus thermostatic valve, axial left or right. GW 1/2” / GZ 1/2”, mounting thread M30x1.5. Economical version.

Without pre-setting.

MASTER, 1/2"x1/2"



Color	Type	Catalog number	Price
Nickel	Left	000M772A001	59 zł
Nickel	Right	000M773A001	59 zł

Arcus thermostatic valve, axial left or right. GW 1/2” / GZ 1/2”, mounting thread M30x1.5. Economical version. It has a valve setting ring.

RADIATOR VALVES

FP20, 3/4" x 3/4"



Color	Type	Catalog number	Price
Nickel	Straight	000M621A002	80 zł

„FP20” thermostatic valve, straight.
Mounting thread M30x1.5.

Without pre-setting.

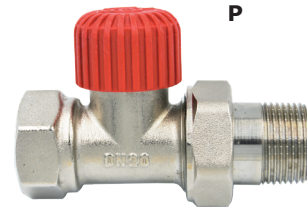

AXI, 1/2" x 1/2"



Color	Type	Catalog number	Price
Nickel	Axial	02.13.01	50 zł

„Axi” axial thermostatic valve GW 1/2" / GZ 1/2", designed for side-powered heaters. It enables the head to be directed parallel to the radiator. Mounting thread M30x1.5.

Without pre-setting.

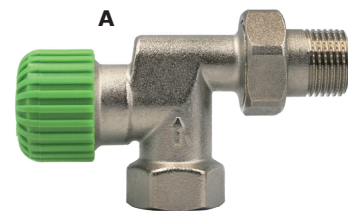

SWING 2, 1/2" x 1/2"



Color	Type	Catalog number	Price
Nickel	Straight	2801	29 zł
Nickel	Angular	2804	29 zł

„Swing 2” control valve, angular or straight. Large flow diameter. GW 1/2" / GZ 1/2". Regulating knob protected with a plastic cover.

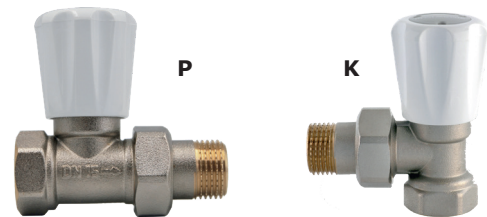

FP / FK, 1/2" x 1/2"

Color	Type	Catalog number	Price
Nickel	Straight	000M869A002	20 zł
Nickel	Angular	000M870A002	20 zł

Straight „FP” or angle „FK” shut-off valve. GW 1/2" / GZ 1/2".

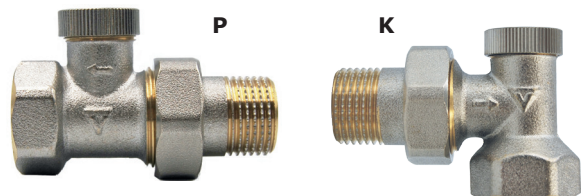

TYPE V, 3/4" x 3/4"

Color	Type	Catalog number	Price
Nickel	Straight	000M856A001	46 zł
Nickel	Angular	000M855A001	46 zł

„Type V” two-pipe connection valve GW 3/4" / GZ 3/4", Angular or Straight. Connection distance 50mm.

Type V valve without nipples.



UNO, 1/2" x 3/4" x 3/4"



Color	Type	Catalog number	Price
Nickel	Right	000M858A001	148 zł

UNO connection, right. GZ 1/2" / GZ 3/4" x GZ 3/4". Connection distance 50mm. The economic version. The valve has a dip tube.

It has a pre-setting.

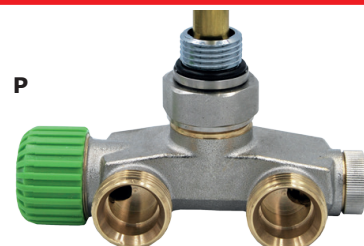

ECONOMIC SETS

ECON

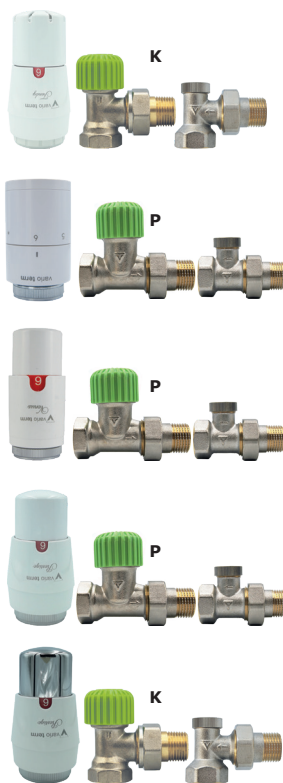

Name	Type	Version	Catalog number	Price
Trendy	GS.05-106C	Straight	EGS05106C/FP	87 zł
Trendy	GS.05-106C	Angular	EGS05106C/FK	87 zł
Pony	GS.10-06C	Straight	EGS1006C/FP	88 zł
Pony	GS.10-06C	Angular	EGS1006C/FK	88 zł
Venus II	GS.09-106C	Straight	EGS09106C/FP	98 zł
Venus II	GS.09-106C	Angular	EGS09106C/FK	98 zł
Prestige	GS.02-06C	Straight	EGS0206C/FP	95 zł
Prestige	GS.02-06C	Angular	EGS0206C/FK	95 zł
Prestige	GS.02-01C	Straight	EGS0201C/FP	98 zł
Prestige	GS.02-01C	Angular	EGS0201C/FK	98 zł

„Econ” thermostatic set, angular or straight version, GW ½” / GZ ½”.

The set includes:

- 1x thermostatic valve „EFK” or „EFP”,
- 1x shut-off valve „FK” or „FP”,
- 1x thermostatic head „Trendy” or „Pony” or „Venus II” or „Prestige”.

The valve is equipped with an economic pre-setting.

ARCUS

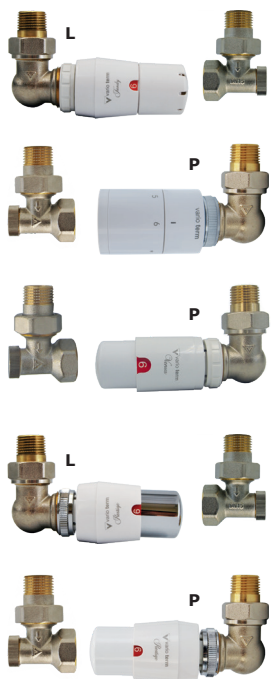

Name	Type	Version	Catalog number	Price
Trendy	GS.05-106C	Left	ARGS05106C/L	113 zł
Trendy	GS.05-106C	Right	ARGS05106C/P	113 zł
Pony	GS.10-06C	Left	ARGS1006C/L	116 zł
Pony	GS.10-06C	Right	ARGS1006C/P	116 zł
Venus II	GS.09-106C	Left	ARGS09106C/L	121 zł
Venus II	GS.09-106C	Right	ARGS09106C/P	121 zł
Prestige	GS.02-06C	Left	ARGS0206C/L	120 zł
Prestige	GS.02-06C	Right	ARGS0206C/P	120 zł
Prestige	GS.02-01C	Left	ARGS0201C/L	121 zł
Prestige	GS.02-01C	Right	ARGS0201C/P	121 zł

„Arcus” thermostatic set, axial left or right version, GW ½” / GZ ½”.

The set includes:

- 1x „Arcus” thermostatic valve,
- 1x shut-off valve „FK” or „FP”,
- 1x thermostatic head „Trendy” or „Pony” or „Venus II” or „Prestige”.



ECONOMIC SETS

AXI EKONOMICZNY

Name	Type	Version	Catalog number	Price
Trendy	GS.05-106C	Axial	AXIGS05106C	119 zł
Pony	GS.10-06C	Axial	AXIGS1006C	122 zł
Venus II	GS.09-106C	Axial	AXIGS09106C	129 zł
Prestige	GS.02-06C	Axial	AXIGS0206C	128 zł
Prestige	GS.02-01C	Axial	AXIGS0201C	129 zł

„Axi Economical” thermostatic set, Axial version, GW ½” / GZ ½”.

The set includes:

1x „Axi” radiator valve,

1x shut-off valve „FK”,

1x thermostatic head „Trendy” or „Pony” or „Venus II” or „Prestige”.

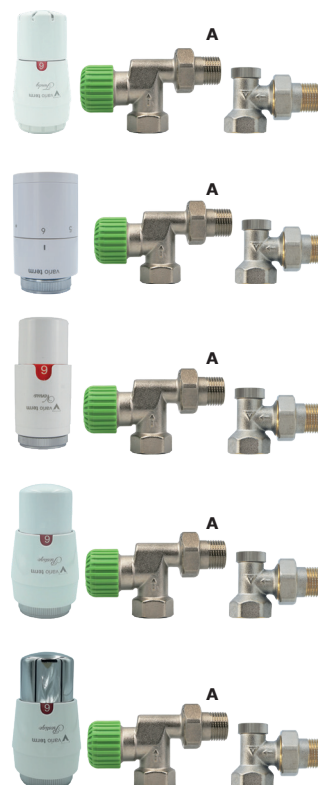

SWING 2

Color	Version	Catalog number	Price
Nickel	Angular	ZI00/RFK	42 zł
Nickel	Straight	ZI00/RFP	42 zł

„Swing 2” adjustment set Angular or straight version GW ½” / GZ ½”.

The set includes:

1x „EFK” or „EFP” radiator valve,

1x „FK” or „FP” shut-off valve.

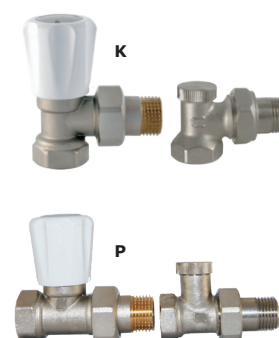

SIMPLE

Color	Version	Catalog number	Price
Nickel	Angular	SI00/EFK	59 zł
Nickel	Straight	SI00/EFP	59 zł

„Simple” regulating set, angular or straight version GW ½” / GZ ½”.

The set includes:

1x „EFK” or „EFP” radiator valve,

1x „FK” or „FP” shut-off valve.

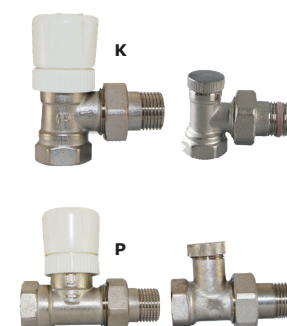

ECONOMIC SETS

STANDARD



Name	Type	Version	Catalog number	Price
Trendy	GS.05-106C	Straight	STGS05106C/FP	108 zł
Trendy	GS.05-106C	Angular	STGS05106C/FK	108 zł
Pony	GS.10-06C	Straight	STGS1006C/FP	109 zł
Pony	GS.10-06C	Angular	STGS1006C/FK	109 zł
Venus II	GS.09-106C	Straight	STGS09106C/FP	119 zł
Venus II	GS.09-106C	Angular	STGS09106C/FK	119 zł
Prestige	GS.02-06C	Straight	STGS0206C/FP	117 zł
Prestige	GS.02-06C	Angular	STGS0206C/FK	117 zł
Prestige	GS.02-01C	Straight	STGS0201C/FP	119 zł
Prestige	GS.02-01C	Angular	STGS0201C/FK	119 zł

„Standard” thermostatic set, angular or straight version, GW ½” / MZ ½”.

The set includes:

1x thermostatic valve „SFK 15” or „SFP 15”,

1x shut-off valve „FK” or „FP”,

1x thermostatic head „Pony” or „Trendy” or „Venus II” or „Prestige”.

The valve is equipped with a pre-setting.

MASTER

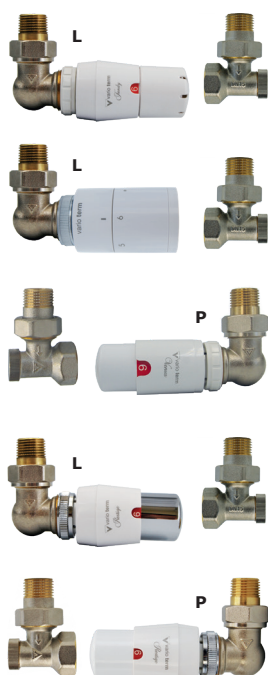

Name	Type	Version	Catalog number	Price
Trendy	GS.05-106C	Left	MAGS05106C/L	117 zł
Trendy	GS.05-106C	Right	MAGS05106C/P	117 zł
Pony	GS.10-06C	Left	MAGS1006C/L	119 zł
Pony	GS.10-06C	Right	MAGS1006C/P	119 zł
Venus II	GS.09-106C	Left	MAGS09106C/L	124 zł
Venus II	GS.09-106C	Right	MAGS09106C/P	124 zł
Prestige	GS.02-06C	Left	MAGS0206C/L	123 zł
Prestige	GS.02-06C	Right	MAGS0206C/P	123 zł
Prestige	GS.02-01C	Left	MAGS0201C/L	124 zł
Prestige	GS.02-01C	Right	MAGS0201C/P	124 zł

„Master” thermostatic set, axial version left or right, GW ½” / GZ ½”.

The set includes:

1x thermostatic valve „Master”,

1x shut-off valve „FK”,

1x thermostatic head „Pony” or „Trendy” or „Venus II” or „Prestige”.

The valve is equipped with a pre-setting.

ECONOMIC SETS

VERSO

Name	Type	Version	Catalog number	Price
Trendy	GS.05-106C	Left	VEGS05106CFK/L	145 zł
Trendy	GS.05-106C	Right	VEGS05106CFK/P	145 zł
Pony	GS.10-06C	Left	VEGS1006CFK/L	149 zł
Pony	GS.10-06C	Right	VEGS1006CFK/P	149 zł
Prestige	GS.02-06C	Left	VEGS0206CFK/L	154 zł
Prestige	GS.02-06C	Right	VEGS0206CFK/P	154 zł

Installation set „Verso” for connection with PEX systems, Axial left or right version, GW 1/2” / GZ 1/2”.

The set includes:

- 1x thermostatic valve „VERSO”,
- 1x shut-off valve „FK”,
- 1x thermostatic head „Trendy” „Pony” or „Prestige”,
- 2x 1/2” PEX connector.

The valve is equipped with a pre-setting.



UNO

Name	Type	Version	Catalog number	Price
Trendy	GS.05-106C	Right	UNGS05106CFK/P	184 zł
Pony	GS.10-06C	Right	UNGS1006CFK/P	189 zł
Prestige	GS.02-06C	Right	UNGS0206CFK/P	194 zł

Connection set „Uno”, Right version, GZ 1/2” / GZ 3/4” x GZ 3/4”. The distance between the connections to the installation is 50 mm.

The set includes:

- 1x „Uno” connection,
- 1x dip tube,
- 1x thermostatic head „Trendy”, „Pony” or „Prestige”.



*FOR STANDARD SERIES SETS (EXCEPT MASTER SET *)
IT IS POSSIBLE TO SELECT PEX COUPLINGS FOR VALVES.*

WHEN ORDERING, PLEASE ADD (PEX) AT THE END OF THE CATALOG NUMBER.

EXAMPLE: STGS0201C / FK (PEX).

** CONNECTORS FOR THE MASTER SET - PAGE 71 - „GZ 1/2” x PEX TWISTED COUPLING”,
THE COUPLINGS ARE INCLUDED IN THE VERSO KITS.*

ECONOMIC SETS

TYPE V



Name	Thread	Type	Version	Nipp.	Catalog number	Price
Trendy	M30x1,5	GS.05-106C	Straight	+	PRNYGS05106C/FP	92 zł
Trendy	M30x1,5	GS.05-106C	Straight	-	PRGS05106C/FP	83 zł
Trendy	M30x1,5	GS.05-106C	Angular	+	PRNYGS05106C/FK	92 zł
Trendy	M30x1,5	GS.05-106C	Angular	-	PRGS05106C/FK	83 zł



Name	Thread	Type	Version	Nipp.	Catalog number	Price
Pony	M30x1,5	GS.10-06C	Straight	+	PRNYGS1006C/FP	92 zł
Pony	M30x1,5	GS.10-06C	Straight	-	PRGS1006C/FP	84 zł
Pony	M30x1,5	GS.10-06C	Angular	+	PRNYGS1006C/FK	92 zł
Pony	M30x1,5	GS.10-06C	Angular	-	PRGS1006C/FK	84 zł



Name	Thread	Type	Version	Nipp.	Catalog number	Price
Trendy	Click	GS.07-306C	Straight	+	PRNYGS07306C/FP	104 zł
Trendy	Click	GS.07-306C	Straight	-	PRGS07306C/FP	94 zł
Trendy	Click	GS.07-306C	Angular	+	PRNYGS07306C/FK	104 zł
Trendy	Click	GS.07-306C	Angular	-	PRGS07306C/FK	94 zł



Name	Thread	Type	Version	Nipp.	Catalog number	Price
Venus II	M30x1,5	GS.09-106C	Straight	+	PRNYGS09C/FP	101 zł
Venus II	M30x1,5	GS.09-106C	Straight	-	PRGS09C/FP	92 zł
Venus II	M30x1,5	GS.09-106C	Angular	+	PRNYGS09C/FK	101 zł
Venus II	M30x1,5	GS.09-106C	Angular	-	PRGS09C/FK	92 zł

„Type V” thermostatic set, angular or straight version, GZ ¾” / GW ¾”. The distance between the connections to the installation is 50 mm. The valves are compatible with „Type V radiators.

The set includes:

- 1x two-pipe connection valve „Type V”,
- 1x thermostatic head „Pony” or „Trendy” or „Venus II”,
- 2x reduction nipples (in selected sets „+”)

For „Type V” sets of the Standard series PEX connectors can be selected for valves with thread to them adapted.

When ordering, it should be at the end add the catalog number (PEX).

Example: PRGS0506C / FP (PEX).



Name	Thread	Type	Version	Nipp.	Catalog number	Price
Prestige	M30x1,5	GS.02-06C	Straight	+	PRNYGS0206C/FP	98 zł
Prestige	M30x1,5	GS.02-06C	Straight	-	PRGS0206C/FP	89 zł
Prestige	M30x1,5	GS.02-06C	Angular	+	PRNYGS0206C/FK	98 zł
Prestige	M30x1,5	GS.02-06C	Angular	-	PRGS0206C/FK	89 zł



Name	Thread	Type	Version	Nipp.	Catalog number	Price
Prestige	M30x1,5	GS.02-01C	Straight	+	PRNYGS0206C/FP	101 zł
Prestige	M30x1,5	GS.02-01C	Straight	-	PRGS0206C/FK	92 zł
Prestige	M30x1,5	GS.02-01C	Angular	+	PRNYGS0201C/FP	101 zł
Prestige	M30x1,5	GS.02-01C	Angular	-	PRGS0201C/FK	92 zł



Name	Thread	Type	Version	Nipp.	Catalog number	Price
Prestige	Click	GS.04-106C	Straight	+	PRNYGS04106C/FP	110 zł
Prestige	Click	GS.04-106C	Straight	-	PRGS04106C/FP	101 zł
Prestige	Click	GS.04-106C	Angular	+	PRNYGS04106C/FK	110 zł
Prestige	Click	GS.04-106C	Angular	-	PRGS04106C/FK	101 zł



Name	Thread	Type	Version	Nipp.	Catalog number	Price
Prestige	Click	GS.04-101C	Straight	+	PRNYGS04101C/FP	114 zł
Prestige	Click	GS.04-101C	Straight	-	PRGS04101C/FP	104 zł
Prestige	Click	GS.04-101C	Angular	+	PRNYGS04101C/FK	114 zł
Prestige	Click	GS.04-101C	Angular	-	PRGS04101C/FK	104 zł



Installation kit „Type V”, angular or straight version, GZ ¾” / GW ¾”. The distance between the connections to the installation is 50 mm. The valves are compatible with Type V radiators.

The set includes:

- 1x two-pipe connection valve „Type V”,
- 1x thermostatic head „Prestige”,
- 2x reduction nipples (in selected sets „+”)



INSTALLATION SETS

Technical data:

Range	8°C – 30°C* (16°C - 30°C)
Work temperature	120°C
Nominal pressure	1MPa
Heating medium	water
Test pressure	1.5 MPa
Pre-setting	on the valve insert shut-off
Radiator connection	G 3/4

For more demanding users who care about the color matching of the fittings to the radiator, the Elegant sets are designed, in which most valves have a set point. The highest category of Vario Term products are Exclusive sets. There is a full range of colors available for them along with the coating of structural varnishes, individual orders for unusual colors are also possible, eg gold, pink, green etc. They are the best quality products dedicated to the most expensive decorative radiators. A full range of colors is available for them, together with a coating of structural varnishes, they are possible with color-matched fittings in any color from the RAL palette.

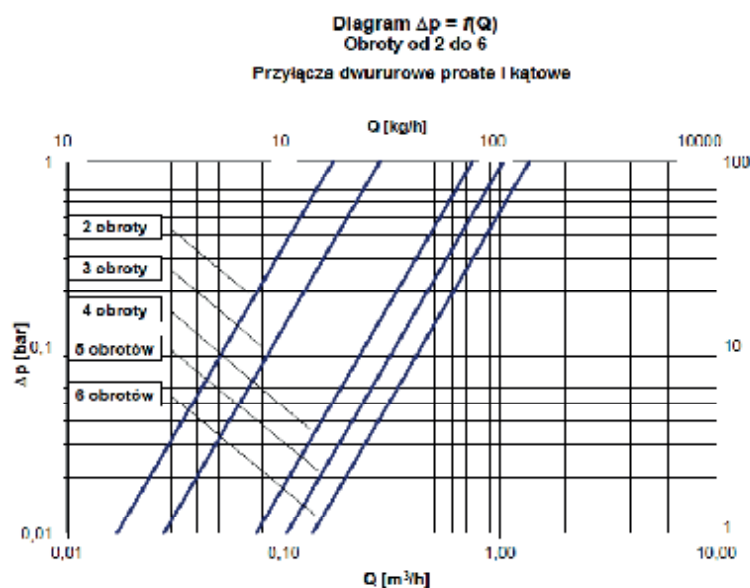

MASTER THERMOSTATIC SET, LEFT, WITH PRESTIGE THERMOSTATIC HEAD

TYPE V ELEGANT



„Type V Elegant“ thermostatic set, angle or straight version, GW $\frac{3}{4}$ " / GZ $\frac{3}{4}$ ".

The set includes: „Type V“ connection valve, „Prestige“ / „Picco“ thermostatic head.

Additionally, it is possible to choose PEX connectors for valves with a thread adapted to them (when ordering, please add (PEX) at the end of the catalog number - example: EPRNYGS0224C/FK(PEX)).

Important information! Fittings (pages 70-71) are not included in the set price!

* Color 01 thermostatic set: White-Chrome „Prestige“ or „Picco“ thermostatic head with white „Type V“ connection valve.

No.	Color	With PRESTIGE thermostatic head	Price	With PICCO thermostatic head	Price
01	*White - Chrome	EPRNYGS0201C/FK, EPRNYGS0201C/FP	151 zł	EPRNYGS02101P/FK, EPRNYGS02101P/FP	182 zł
03	Satin	EPRNYGS0203C/FK, EPRNYGS0203C/FP	258 zł	EPRNYGS02103P/FK, EPRNYGS02103P/FP	289 zł
04	Gold	EPRNYGS0204C/FK, EPRNYGS0204C/FP	227 zł	EPRNYGS02104P/FK, EPRNYGS02104P/FP	259 zł
05	Structural graphite	EPRNYGS0205C/FK, EPRNYGS0205C/FP	227 zł	EPRNYGS02105P/FK, EPRNYGS02105P/FP	259 zł
06	White	EPRNYGS0206C/FK, EPRNYGS0206C/FP	151 zł	EPRNYGS02106P/FK, EPRNYGS02106P/FP	182 zł
07	Glossy anth./Graph.	EPRNYGS0207C/FK, EPRNYGS0207C/FP	227 zł	EPRNYGS02107P/FK, EPRNYGS02107P/FP	259 zł
08	Nickel-grinded	-	-	-	-
09	Sand structural	EPRNYGS0209C/FK, EPRNYGS0209C/FP	227 zł	EPRNYGS02109P/FK, EPRNYGS02109P/FP	259 zł
10	Dark sand structural	EPRNYGS0210C/FK, EPRNYGS0210C/FP	227 zł	EPRNYGS02110P/FK, EPRNYGS02110P/FP	259 zł
11	Antique brass	EPRNYGS0211C/FK, EPRNYGS0211C/FP	258 zł	EPRNYGS02111P/FK, EPRNYGS02111P/FP	289 zł
12	Metallic graphite	EPRNYGS0212C/FK, EPRNYGS0212C/FP	227 zł	EPRNYGS02112P/FK, EPRNYGS02112P/FP	259 zł
13	Glossy black	EPRNYGS0213C/FK, EPRNYGS0213C/FP	227 zł	EPRNYGS02113P/FK, EPRNYGS02113P/FP	259 zł
14	Structural black	EPRNYGS0214C/FK, EPRNYGS0214C/FP	227 zł	EPRNYGS02114P/FK, EPRNYGS02114P/FP	259 zł
15	Dark str. graphite	EPRNYGS0215C/FK, EPRNYGS0215C/FP	227 zł	EPRNYGS02115P/FK, EPRNYGS02115P/FP	259 zł
16	Structural maroon	EPRNYGS0216C/FK, EPRNYGS0216C/FP	227 zł	EPRNYGS02116P/FK, EPRNYGS02116P/FP	259 zł
17	Gray metallic	EPRNYGS0217C/FK, EPRNYGS0217C/FP	227 zł	EPRNYGS02117P/FK, EPRNYGS02117P/FP	259 zł
18	Granite	EPRNYGS0218C/FK, EPRNYGS0218C/FP	227 zł	EPRNYGS02118P/FK, EPRNYGS02118P/FP	259 zł
19	Structural white	EPRNYGS0219C/FK, EPRNYGS0219C/FP	227 zł	EPRNYGS02119P/FK, EPRNYGS02119P/FP	259 zł
21	Matt white	EPRNYGS0221C/FK, EPRNYGS0221C/FP	227 zł	EPRNYGS02121P/FK, EPRNYGS02121P/FP	259 zł
24	Matt black	EPRNYGS0224C/FK, EPRNYGS0224C/FP	227 zł	EPRNYGS02124P/FK, EPRNYGS02124P/FP	259 zł



TYPE V ELEGANT, STRAIGHT

ELEGANT SETS

BALL



„BALL” installation set, angular, GW 1/2” / GZ 1/2”. For retro radiators. The set includes: „Ball” control valve, „Ball” shut-off valve.

Additionally, it is possible to select PEX connectors for valves with a thread adapted to them (when ordering, add (PEX) at the end of the catalog number - example: ZIS15 / FK (PEX)).

Important information Fittings (pages 70-71) are not included in the set price!

No.	Color	Type (angular)	Price
02	Chrome	ZIB02/FK	182 zł
03	Satin	ZIB03/FK	250 zł
04	Gold	ZIB04/FK	216 zł
05	Structural graphite	ZIB05/FK	216 zł
06	White	ZIB06/FK	182 zł
07	Glossy anth./Graph.	ZIB07/FK	216 zł
08	Nickel-grinded	ZIB08/FK	250 zł
09	Sand structural	ZIB09/FK	216 zł
10	Dark sand structural	ZIB10/FK	216 zł
11	Antique brass	ZIB11/FK	250 zł
12	Metallic graphite	ZIB12/FK	216 zł
13	Glossy black	ZIB13/FK	216 zł
14	Structural black	ZIB14/FK	216 zł
15	Dark str. graphite	ZIB15/FK	216 zł
16	Structural maroon	ZIB16/FK	216 zł
17	Gray metallic	ZIB17/FK	216 zł
18	Granite	ZIB18/FK	216 zł
19	Structural white	ZIB19/FK	216 zł
21	Matt white	ZIB21/FK	216 zł
24	Matt black	ZIB24/FK	216 zł



BALL, ANGLULAR



„Swing” regulating set, angular or straight version, GW ½” / GZ ½”.

The set includes: „Swing” control valve, „Swing” shut-off valve.

In addition, it is possible to choose PEX fittings for valves with a thread adapted to them (when ordering, add (PEX) at the end of the catalog number - example: ZIS03/FK(PEX))

Important information Fittings (pages 70-71) are not included in the set price!

No.	Color	Type (angular, straight)	Price
02	Chrome	ZIS02/FK, ZIS02/FP	147 zł
03	Satin	ZIS03/FK, ZIS03/FP	227 zł
04	Gold	ZIS04/FK, ZIS04/FP	182 zł
05	Structural graphite	ZIS05/FK, ZIS05/FP	181 zł
06	White	ZIS06/FK, ZIS06/FP	147 zł
07	Glossy anth./Graph.	ZIS07/FK, ZIS07/FP	181 zł
08	Nickel-grinded	ZIS08/FK, ZIS08/FP	227 zł
09	Sand structural	ZIS09/FK, ZIS09/FP	181 zł
10	Dark sand structural	ZIS10/FK, ZIS10/FP	181 zł
11	Antique brass	ZIS11/FK, ZIS11/FP	227 zł
12	Metallic graphite	ZIS12/FK, ZIS12/FP	181 zł
13	Glossy black	ZIS13/FK, ZIS13/FP	181 zł
14	Structural black	ZIS14/FK, ZIS14/FP	181 zł
15	Dark str. graphite	ZIS15/FK, ZIS15/FP	181 zł
16	Structural maroon	ZIS16/FK, ZIS16/FP	181 zł
17	Gray metallic	ZIS17/FK, ZIS17/FP	181 zł
18	Granite	ZIS18/FK, ZIS18/FP	181 zł
19	Structural white	ZIS19/FK, ZIS19/FP	181 zł
21	Matt white	ZIS21/FK, ZIS21/FP	181 zł
24	Matt black	ZIS24/FK, ZIS24/FP	181 zł

ELEGANT SETS

WITH PRE-SETTING

AXI ELEGANT



„Axi Elegant“ thermostatic set, axial version, GW 1/2" / GZ 1/2".
The set includes: „Axi“ thermostatic valve, „FK“ shut-off valve, „Prestige“ thermostatic head or „Picco“ thermostatic head.

Additionally, it is possible to choose PEX connectors for valves with a thread adapted to them (when ordering, please add (PEX) at the end of the catalog number - example: EMAGS10211CFK/L(PEX)).

Important information Fittings (pages 70-71) are not included in the set price!

No.	Color	With PRESTIGE thermostatic head	Price	With PICCO thermostatic head	Price
01	White-Chrome	EAXIGS0201C	193 zł	EAXIGS02101P	225 zł
03	Satin	EAXIGS0203C	261 zł	EAXIGS02103P	293 zł
04	Gold	EAXIGS0204C	227 zł	EAXIGS02104P	259 zł
05	Structural graphite	EAXIGS0205C	227 zł	EAXIGS02105P	259 zł
06	White	EAXIGS0206C	193 zł	EAXIGS02106P	225 zł
07	Glossy anth./Graph.	EAXIGS0207C	227 zł	EAXIGS02107P	259 zł
08	Nickel-grinded	-	-	-	-
09	Sand structural	EAXIGS0209C	227 zł	EAXIGS02109P	259 zł
10	Dark sand structural	EAXIGS0210C	227 zł	EAXIGS02110P	259 zł
11	Antique brass	EAXIGS0211C	261 zł	EAXIGS02111P	293 zł
12	Metallic graphite	EAXIGS0212C	227 zł	EAXIGS02112P	259 zł
13	Glossy black	EAXIGS0213C	227 zł	EAXIGS02113P	259 zł
14	Structural black	EAXIGS0214C	227 zł	EAXIGS02114P	259 zł
15	Dark str. graphite	EAXIGS0215C	227 zł	EAXIGS02115P	259 zł
16	Structural maroon	EAXIGS0216C	227 zł	EAXIGS02116P	259 zł
17	Gray metallic	EAXIGS0217C	227 zł	EAXIGS02117P	259 zł
18	Granite	EAXIGS0218C	227 zł	EAXIGS02118P	259 zł
19	Structural white	EAXIGS0219C	227 zł	EAXIGS02119P	259 zł
21	Matt white	EAXIGS0221C	227 zł	EAXIGS02121P	259 zł
24	Matt black	EAXIGS0224C	227 zł	EAXIGS02124P	259 zł



AXI ELEGANT, WITH PRESTIGE THERMOSTATIC HEAD

ELEGANT SETS

WITH PRE-SETTING

MASTER



Thermostatic set „Master”, axial left or right, GW ½”, GZ ½”.

The set includes: „Master” thermostatic valve, „FK” shut-off valve, thermostatic head „Prestige” thermostatic head or „Picco” thermostatic head.

Additionally, it is possible to choose PEX connectors for valves with a thread adapted to them (when ordering, please add (PEX) at the end of the catalog number - example: EMAGS10211CFK/L(PEX)).

Important information Fittings (pages 70-71) are not included in the set price!

No.	Color	With PRESTIGE thermostatic head	Price	With PICCO thermostatic head	Price
01	White-Chrome	EMAGS0201CFK/L, EMAGS0201CFK/P	219 zł	EMAGS02101PFK/L, EMAGS02101PFK/P	251 zł
03	Satin	EMAGS0203CFK/L, EMAGS0203CFK/P	283 zł	EMAGS02103PFK/L, EMAGS02103PFK/P	315 zł
04	Gold	EMAGS0204CFK/L, EMAGS0204CFK/P	239 zł	EMAGS02104PFK/L, EMAGS02104PFK/P	270 zł
05	Structural graphite	EMAGS0205CFK/L, EMAGS0205CFK/P	239 zł	EMAGS02105PFK/L, EMAGS02105PFK/P	270 zł
06	White	EMAGS0206CFK/L, EMAGS0206CFK/P	216 zł	EMAGS02106PFK/L, EMAGS02106PFK/P	248 zł
07	Glossy anth./Graph.	EMAGS0207CFK/L, EMAGS0207CFK/P	239 zł	EMAGS02107PFK/L, EMAGS02107PFK/P	270 zł
08	Nickel-grinded	-	-	-	-
09	Piaskowy struktur	EMAGS0209CFK/L, EMAGS0209CFK/P	239 zł	EMAGS02109PFK/L, EMAGS02109PFK/P	270 zł
10	Dark sand structural	EMAGS0210CFK/L, EMAGS0210CFK/P	239 zł	EMAGS02110PFK/L, EMAGS02110PFK/P	270 zł
11	Antique brass	EMAGS0211CFK/L, EMAGS0211CFK/P	283 zł	EMAGS02111PFK/L, EMAGS02111PFK/P	315 zł
12	Metallic graphite	EMAGS0212CFK/L, EMAGS0212CFK/P	239 zł	EMAGS02112PFK/L, EMAGS02112PFK/P	270 zł
13	Glossy black	EMAGS0213CFK/L, EMAGS0213CFK/P	239 zł	EMAGS02113PFK/L, EMAGS02113PFK/P	270 zł
14	Structural black	EMAGS0214CFK/L, EMAGS0214CFK/P	239 zł	EMAGS02114PFK/L, EMAGS02114PFK/P	270 zł
15	Dark str. graphite	EMAGS0215CFK/L, EMAGS0215CFK/P	239 zł	EMAGS02115PFK/L, EMAGS02115PFK/P	270 zł
16	Structural maroon	EMAGS0216CFK/L, EMAGS0216CFK/P	239 zł	EMAGS02116PFK/L, EMAGS02116PFK/P	270 zł
17	Gray metallic	EMAGS0217CFK/L, EMAGS0217CFK/P	239 zł	EMAGS02117PFK/L, EMAGS02117PFK/P	270 zł
18	Granite	EMAGS0218CFK/L, EMAGS0218CFK/P	239 zł	EMAGS02118PFK/L, EMAGS02118PFK/P	270 zł
19	Structural white	EMAGS0219CFK/L, EMAGS0219CFK/P	239 zł	EMAGS02119PFK/L, EMAGS02119PFK/P	270 zł
21	Matt white	EMAGS0221CFK/L, EMAGS0221CFK/P	239 zł	EMAGS02121PFK/L, EMAGS02121PFK/P	270 zł
24	Matt black	EMAGS0224CFK/L, EMAGS0224CFK/P	239 zł	EMAGS02124PFK/L, EMAGS02124PFK/P	270 zł



MASTER, RIGHT, WITH PRESTIGE THERMOSTATIC HEAD

ZESTAWY ELEGANCKIE

WITH PRE-SETTING

ELEGANT



„Elegant” thermostatic set, angular or straight, GW ½” / GZ ½”.

The set includes: „SFK” or „SFP” thermostatic valve, „FK” or „FP” shut-off valve, „Prestige” thermostatic head or „Picco” thermostatic head.

Additionally, it is possible to choose PEX connectors for valves with a thread adapted to them (when ordering, add (PEX) at the end of the catalog number - example: ELGS0207C/FK(PEX)).

Important information Fittings (pages 70-71) are not included in the set price!

No.	Color	With PRESTIGE thermostatic head	Price	With PICCO thermostatic head	Price
01	White-Chrome	ELGS0201C/FK, ELGS0201C/FP	192 zł	ELGS02101P/FK, ELGS02101P/FP	224 zł
03	Satin	ELGS0203C/FK, ELGS0203C/FP	268 zł	ELGS02103P/FK, ELGS02103P/FP	300 zł
04	Gold	ELGS0204C/FK, ELGS0204C/FP	223 zł	ELGS02104P/FK, ELGS02104P/FP	254 zł
05	Structural graphite	ELGS0205C/FK, ELGS0205C/FP	223 zł	ELGS02105P/FK, ELGS02105P/FP	254 zł
06	White	ELGS0206C/FK, ELGS0206C/FP	192 zł	ELGS02106P/FK, ELGS02106P/FP	224 zł
07	Glossy anth./Graph.	ELGS0207C/FK, ELGS0207C/FP	223 zł	ELGS02107P/FK, ELGS02107P/FP	254 zł
08	Nickel-grinded	-	-	-	-
09	Sand structural	ELGS0209C/FK, ELGS0209C/FP	223 zł	ELGS02109P/FK, ELGS02109P/FP	254 zł
10	Dark sand structural	ELGS0210C/FK, ELGS0210C/FP	223 zł	ELGS02110P/FK, ELGS02110P/FP	254 zł
11	Antique brass	ELGS0211C/FK, ELGS0211C/FP	268 zł	ELGS02111P/FK, ELGS02111P/FP	300 zł
12	Metallic graphite	ELGS0212C/FK, ELGS0212C/FP	223 zł	ELGS02112P/FK, ELGS02112P/FP	254 zł
13	Glossy black	ELGS0213C/FK, ELGS0213C/FP	223 zł	ELGS02113P/FK, ELGS02113P/FP	254 zł
14	Structural black	ELGS0214C/FK, ELGS0214C/FP	223 zł	ELGS02114P/FK, ELGS02114P/FP	254 zł
15	Dark str. graphite	ELGS0215C/FK, ELGS0215C/FP	223 zł	ELGS02115P/FK, ELGS02115P/FP	254 zł
16	Structural maroon	ELGS0216C/FK, ELGS0216C/FP	223 zł	ELGS02116P/FK, ELGS02116P/FP	254 zł
17	Gray metallic	ELGS0217C/FK, ELGS0217C/FP	223 zł	ELGS02117P/FK, ELGS02117P/FP	254 zł
18	Granite	ELGS0218C/FK, ELGS0218C/FP	223 zł	ELGS02118P/FK, ELGS02118P/FP	254 zł
19	Structural white	ELGS0219C/FK, ELGS0219C/FP	223 zł	ELGS02119P/FK, ELGS02119P/FP	254 zł
21	Matt white	ELGS0221C/FK, ELGS0221C/FP	223 zł	ELGS02121P/FK, ELGS02121P/FP	254 zł
24	Matt black	ELGS0224C/FK, ELGS0224C/FP	223 zł	ELGS02124P/FK, ELGS02124P/FP	254 zł

ELEGANT, ANGULAR, WITH PRESTIGE THERMOSTATIC HEAD

ZESTAWY ELEGANCKIE

ROYAL



„Royal” thermostatic set, angular or straight, GW ½” / GZ ½”.

The set includes: „Royal” thermostatic valve, „Royal” shut-off valve, „Prestige” thermostatic head or „Picco” thermostatic head.

Additionally, it is possible to select PEX fittings for valves with a thread adapted to them (when ordering, add (PEX) at the end of the catalog number - example: ROGS10214PFK(PEX)).

Important information Fittings (pages 70-71) are not included in the set price!

No.	Color	With PRESTIGE thermostatic head	Price	With PICCO thermostatic head	Price
02	Chrome	ROGS0202CFK, ROGS0202CFP	244 zł	ROGS02102PFK, ROGS02102PFP	276 zł
03	Satin	ROGS0203CFK, ROGS0203CFP	296 zł	ROGS02103PFK, ROGS02103PFP	328 zł
04	Gold	ROGS0204CFK, ROGS0204CFP	267 zł	ROGS02104PFK, ROGS02104PFP	299 zł
05	Structural graphite	ROGS0205CFK, ROGS0205CFP	267 zł	ROGS02105PFK, ROGS02105PFP	299 zł
06	White	ROGS0206CFK, ROGS0206CFP	244 zł	ROGS02106PFK, ROGS02106PFP	276 zł
07	Glossy anth./Graph.	ROGS0207CFK, ROGS0207CFP	267 zł	ROGS02107PFK, ROGS02107PFP	299 zł
08	Nickel-grinded	ROGS0208CFK, ROGS0208CFP	296 zł	ROGS02108PFK, ROGS02108PFP	328 zł
09	Sand structural	ROGS0209CFK, ROGS0209CFP	267 zł	ROGS02109PFK, ROGS02109PFP	299 zł
10	Dark sand structural	ROGS0210CFK, ROGS0210CFP	267 zł	ROGS02110PFK, ROGS02110PFP	299 zł
11	Antique brass	ROGS0211CFK, ROGS0211CFP	296 zł	ROGS02111PFK, ROGS02111PFP	328 zł
12	Metallic graphite	ROGS0212CFK, ROGS0212CFP	267 zł	ROGS02112PFK, ROGS02112PFP	299 zł
13	Glossy black	ROGS0213CFK, ROGS0213CFP	267 zł	ROGS02113PFK, ROGS02113PFP	299 zł
14	Structural black	ROGS0214CFK, ROGS0214CFP	267 zł	ROGS02114PFK, ROGS02114PFP	299 zł
15	Dark str. graphite	ROGS0215CFK, ROGS0215CFP	267 zł	ROGS02115PFK, ROGS02115PFP	299 zł
16	Structural maroon	ROGS0216CFK, ROGS0216CFP	267 zł	ROGS02116PFK, ROGS02116PFP	299 zł
17	Gray metallic	ROGS0217CFK, ROGS0217CFP	267 zł	ROGS02117PFK, ROGS02117PFP	299 zł
18	Granite	ROGS0218CFK, ROGS0218CFP	267 zł	ROGS02118PFK, ROGS02118PFP	299 zł
19	Structural white	ROGS0219CFK, ROGS0219CFP	267 zł	ROGS02119PFK, ROGS02119PFP	299 zł
21	Matt white	ROGS0221CFK, ROGS0221CFP	267 zł	ROGS02121PFK, ROGS02121PFP	299 zł
24	Matt black	ROGS0224CFK, ROGS0224CFP	267 zł	ROGS02124PFK, ROGS02124PFP	299 zł



ROYAL, STRAIGHT, WITH PRESTIGE THERMOSTATIC HEAD

EXCLUSIVE SETS

Attention:

RANGE	8°C – 30°C* (16°C – 30°C)
Work temperature	120°C
Nominal pressure	1MPa
Heating medium	water
Test pressure	1.5 MPa
Pre-setting	on the valve insert shut-off
Radiator connection	G 3/4

- The thermostatic head should be mounted on the return side (if the power supply is on the right, looking at the radiator, the thermostatic head should be on the left side),

- The shut-off insert for the „Twins” connection is factory-set to the open position.

- The pre-setting in the „Twins” connection is made via the insert of the shut-off valve.

To change the initial setting, first tighten the cut-off valve insert (max. 3Nm - slightly tightened), and then, starting from the closed position of the valve insert, turn it counterclockwise by an appropriate number of turns to obtain the desired Kv value shown in the flow diagram above.

THE CORRECT INSTALATION OF THE TWINS CONNECTION

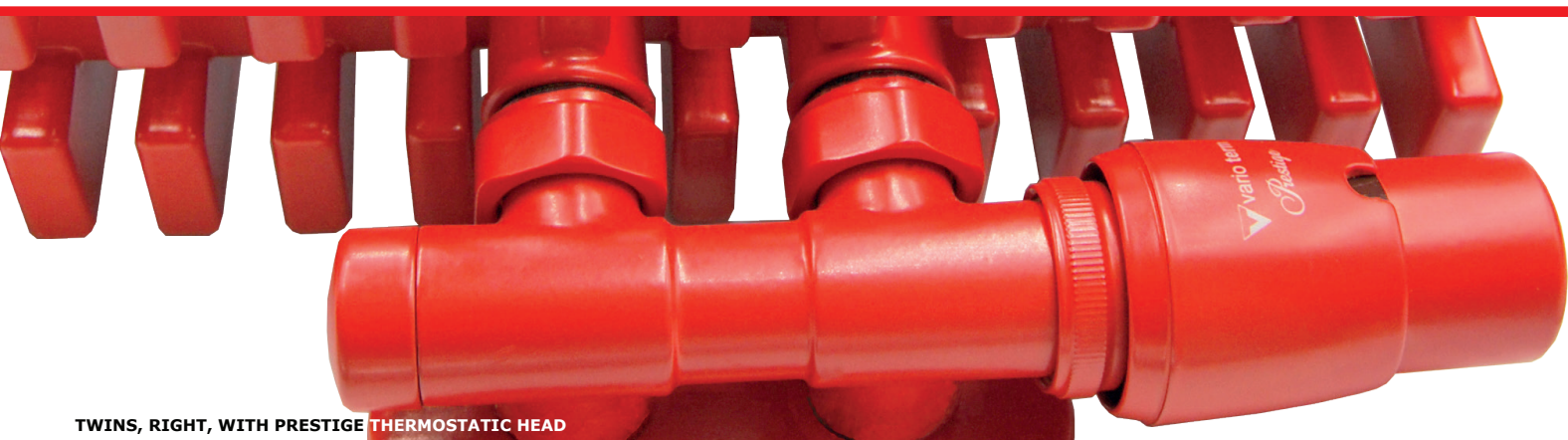
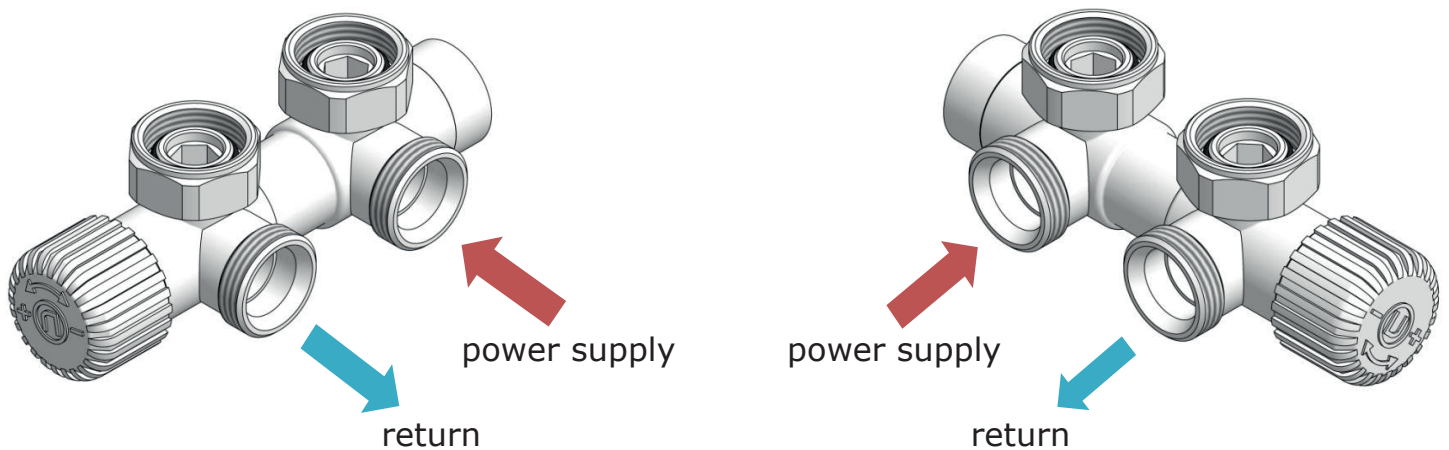

TWINS, RIGHT, WITH PRESTIGE THERMOSTATIC HEAD



„Twins” thermostatic set, right or left, GZ 3/4” / GW 3/4”, connection spacing 50 mm. The set includes: „Twins” thermostatic connection, „Prestige” thermostatic head or „Picco” thermostatic head, reduction nipples.

Correct installation of the „Twins” valves: the drain is on the side of the thermostatic head.

Additionally, it is possible to order sets with connectors for PEX or Cu. The fittings are an integral part of the valve (when ordering, add (PEX) or (Cu) at the end of the catalog number - e.g. TSGS0219CFK/P(PEX)).

Important information Fittings (pages 70-71) are not included in the set price!

No.	Color	With PRESTIGE thermostatic head	Price	With PICCO thermostatic head	Price
02	Chrome	TSGS0202CFK/L, TSGS0202CFK/P	431 zł	TSGS02102PFK/L, TSGS02102PFK/P	463 zł
03	Satin	TSGS0203CFK/L, TSGS0203CFK/P	489 zł	TSGS02103PFK/L, TSGS02103PFK/P	520 zł
04	Gold	TSGS0204CFK/L, TSGS0204CFK/P	454 zł	TSGS02104PFK/L, TSGS02104PFK/P	485 zł
05	Structural graphite	TSGS0205CFK/L, TSGS0205CFK/P	454 zł	TSGS02105PFK/L, TSGS02105PFK/P	485 zł
06	White	TSGS0206CFK/L, TSGS0206CFK/P	431 zł	TSGS02106PFK/L, TSGS02106PFK/P	463 zł
07	Glossy anth./Graph.	TSGS0207CFK/L, TSGS0207CFK/P	454 zł	TSGS02107PFK/L, TSGS02107PFK/P	485 zł
08	Nickel-grinded	TSGS0208CFK/L, TSGS0208CFK/P	489 zł	TSGS02108PFK/L, TSGS02108PFK/P	520 zł
09	Sand structural	TSGS0209CFK/L, TSGS0209CFK/P	454 zł	TSGS02109PFK/L, TSGS02109PFK/P	485 zł
10	Dark sand structural	TSGS0210CFK/L, TSGS0210CFK/P	454 zł	TSGS02110PFK/L, TSGS02110PFK/P	485 zł
11	Antique brass	TSGS0211CFK/L, TSGS0211CFK/P	489 zł	TSGS02111PFK/L, TSGS02111PFK/P	520 zł
12	Metallic graphite	TSGS0212CFK/L, TSGS0212CFK/P	454 zł	TSGS02112PFK/L, TSGS02112PFK/P	485 zł
13	Glossy black	TSGS0213CFK/L, TSGS0213CFK/P	454 zł	TSGS02113PFK/L, TSGS02113PFK/P	485 zł
14	Structural black	TSGS0214CFK/L, TSGS0214CFK/P	454 zł	TSGS02114PFK/L, TSGS02114PFK/P	485 zł
15	Dark str. graphite	TSGS0215CFK/L, TSGS0215CFK/P	454 zł	TSGS02115PFK/L, TSGS02115PFK/P	485 zł
16	Structural maroon	TSGS0216CFK/L, TSGS0216CFK/P	454 zł	TSGS02116PFK/L, TSGS02116PFK/P	485 zł
17	Gray metallic	TSGS0217CFK/L, TSGS0217CFK/P	454 zł	TSGS02117PFK/L, TSGS02117PFK/P	485 zł
18	Granite	TSGS0218CFK/L, TSGS0218CFK/P	454 zł	TSGS02118PFK/L, TSGS02118PFK/P	485 zł
19	Structural white	TSGS0219CFK/L, TSGS0219CFK/P	454 zł	TSGS02119PFK/L, TSGS02119PFK/P	485 zł
21	Matt white	TSGS0221CFK/L, TSGS0221CFK/P	454 zł	TSGS02121PFK/L, TSGS02121PFK/P	485 zł
24	Matt black	TSGS0224CFK/L, TSGS0224CFK/P	454 zł	TSGS02124PFK/L, TSGS02124PFK/P	485 zł

TWINS, RIGHT, WITH PRESTIGE THERMOSTATIC HEAD

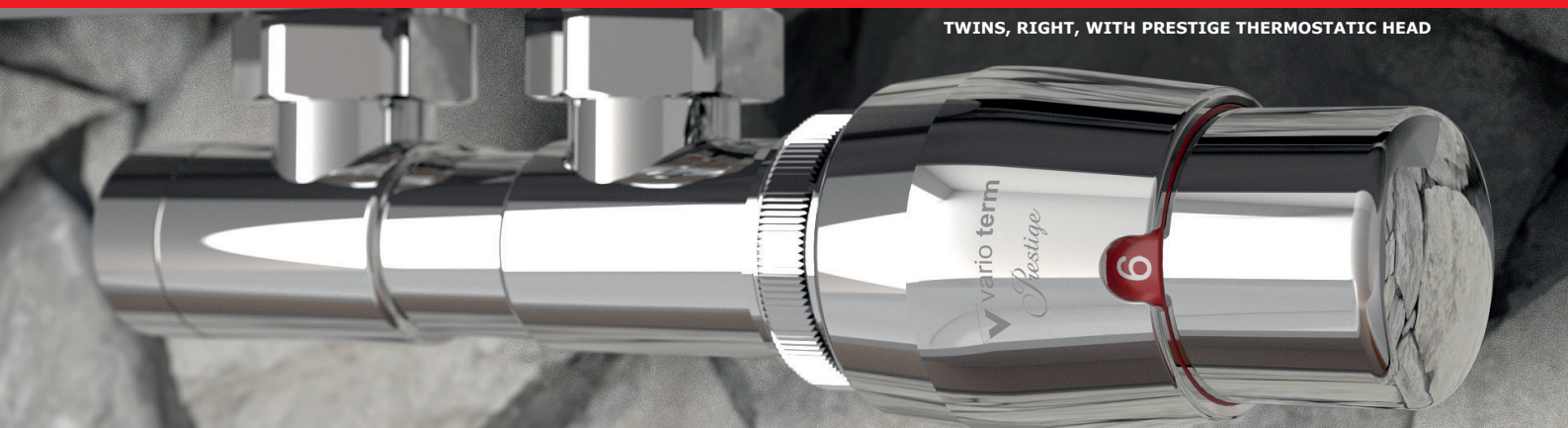

EXCLUSIVE SETS

TWINS REGULATING



„Twins” regulating set, right or left, GZ $\frac{3}{4}$ ” / GW $\frac{3}{4}$ ”, spacing between connections 50 mm.

The set includes: right or left „Twins” adjustment connection, reduction nipples.

Correct installation of „Twins” valves: the drain is on the side of the control knob.

Additionally, it is possible to order sets with connectors for PEX or Cu. Connectors are an integral part of the valve (when ordering, add (PEX) or (Cu) at the end of the catalog number - example: 000M873A009/L(Cu)).

Important information Fittings (pages 70-71) are not included in the set price!

No.	Color	Type (angular, left/right)	Price
02	Chrome	000M873A002/L, 000M873A002/P	296 zł
03	Satin	000M873A003/L, 000M873A003/P	352 zł
04	Gold	000M873A004/L, 000M873A004/P	318 zł
05	Structural graphite	000M873A005/L, 000M873A005/P	318 zł
06	White	000M873A006/L, 000M873A006/P	296 zł
07	Glossy anth./Graph.	000M873A007/L, 000M873A007/P	318 zł
08	Nickel-grinded	000M873A008/L, 000M873A008/P	352 zł
09	Sand structural	000M873A009/L, 000M873A009/P	318 zł
10	Dark sand structural	000M873A010/L, 000M873A010/P	318 zł
11	Antique brass	000M873A011/L, 000M873A011/P	352 zł
12	Metallic graphite	000M873A012/L, 000M873A012/P	318 zł
13	Glossy black	000M873A013/L, 000M873A013/P	318 zł
14	Structural black	000M873A014/L, 000M873A014/P	318 zł
15	Dark str. graphite	000M873A015/L, 000M873A015/P	318 zł
16	Structural maroon	000M873A016/L, 000M873A016/P	318 zł
17	Gray metallic	000M873A017/L, 000M873A017/P	318 zł
18	Granite	000M873A018/L, 000M873A018/P	318 zł
19	Structural white	000M873A019/L, 000M873A019/P	318 zł
21	Matt white	000M873A021/L, 000M873A021/P	318 zł
24	Matt black	000M873A024/L, 000M873A024/P	318 zł



TWINS REGULATING, LEFT

EXCLUSIVE SETS

TWINS SHUT-OFF

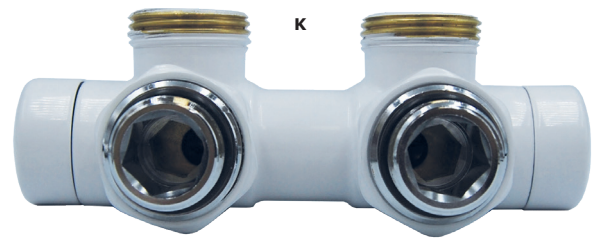
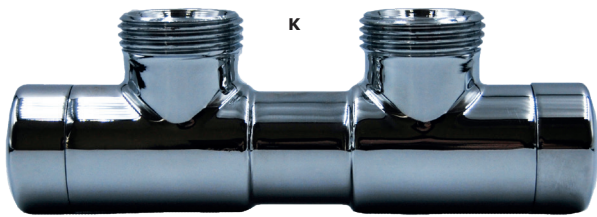

„Twins” shut-off valve, GZ $\frac{3}{4}$ ” / GW $\frac{3}{4}$ ”, spacing between connections 50 mm.
The set includes: „Twins” shut-off connection, reduction nipples.

Additionally, it is possible to order sets with connectors for PEX or Cu. The fittings are an integral part of the valve (when ordering, add (PEX) or (Cu) at the end of the catalog number - example: 000M874A018(PEX)).

Important information Fittings (pages 70-71) are not included in the set price!

No.	Color	Type (angular)	Price
02	Chrome	000M874A002	250 zł
03	Satin	000M874A003	306 zł
04	Gold	000M874A004	272 zł
05	Structural graphite	000M874A005	272 zł
06	White	000M874A006	250 zł
07	Glossy anth./Graph.	000M874A007	272 zł
08	Nickel-grinded	000M874A008	306 zł
09	Sand structural	000M874A009	272 zł
10	Dark sand structural	000M874A010	272 zł
11	Antique brass	000M874A011	306 zł
12	Metallic graphite	000M874A012	272 zł
13	Glossy black	000M874A013	272 zł
14	Structural black	000M874A014	272 zł
15	Dark str. graphite	000M874A015	272 zł
16	Structural maroon	000M874A016	272 zł
17	Gray metallic	000M874A017	272 zł
18	Granite	000M874A018	272 zł
19	Structural white	000M874A019	272 zł
21	Matt white	000M874A021	272 zł
24	Matt black	000M874A024	272 zł

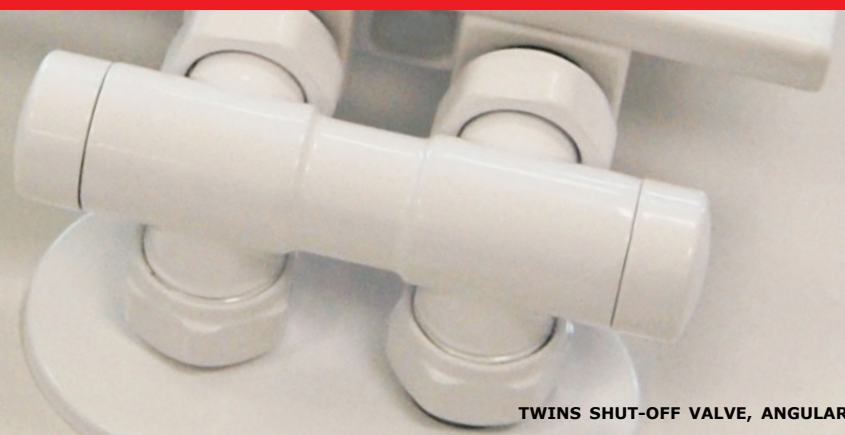

TWINS SHUT-OFF VALVE, ANGULAR

EXCLUSIVE SETS

UNICO

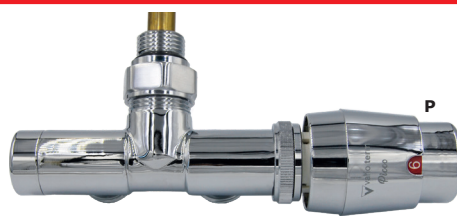

„Unico“ thermostatic set, right or left, GZ $\frac{1}{2}$ ” / GZ $\frac{3}{4}$ ” x GZ $\frac{3}{4}$ ”, connection spacing 50 mm. The valve enables connection of an electric heater in the second riser of the heater.

The set includes: „Unico“ thermostatic connection, immersion tube, „Prestige“ thermostatic head or „Picco“ thermostatic head, reduction nipple.

Correct installation of the Unico valves: the drain is on the side of the thermostatic head.

Additionally, it is possible to order sets with connectors for PEX or Cu. The fittings are an integral part of the valve (when ordering, add (PEX) or (Cu) at the end of the catalog number - example: UGS10204PFK/P(Cu)).

Important information Fittings (pages 70-71) are not included in the set price!

No.	Color	With PRESTIGE thermostatic head	Price	With PICCO thermostatic head	Price
02	Chrome	UGS0202CFK/L, UGS0202CFK/P	448 zł	UGS02102PFK/L, UGS02102PFK/P	480 zł
03	Satin	UGS0203CFK/L, UGS0203CFK/P	494 zł	UGS02103PFK/L, UGS02103PFK/P	526 zł
04	Gold	UGS0204CFK/L, UGS0204CFK/P	472 zł	UGS02104PFK/L, UGS02104PFK/P	504 zł
05	Structural graphite	UGS0205CFK/L, UGS0205CFK/P	472 zł	UGS02105PFK/L, UGS02105PFK/P	504 zł
06	White	UGS0206CFK/L, UGS0206CFK/P	448 zł	UGS02106PFK/L, UGS02106PFK/P	480 zł
07	Glossy anth./Graph.	UGS0207CFK/L, UGS0207CFK/P	472 zł	UGS02107PFK/L, UGS02107PFK/P	504 zł
08	Nickel-grinded	UGS0208CFK/L, UGS0208CFK/P	494 zł	UGS02108PFK/L, UGS02108PFK/P	526 zł
09	Sand structural	UGS0209CFK/L, UGS0209CFK/P	472 zł	UGS02109PFK/L, UGS02109PFK/P	504 zł
10	Dark sand structural	UGS0210CFK/L, UGS0210CFK/P	472 zł	UGS02110PFK/L, UGS02110PFK/P	504 zł
11	Antique brass	UGS0211CFK/L, UGS0211CFK/P	494 zł	UGS02111PFK/L, UGS02111PFK/P	526 zł
12	Metallic graphite	UGS0212CFK/L, UGS0212CFK/P	472 zł	UGS02112PFK/L, UGS02112PFK/P	504 zł
13	Glossy black	UGS0213CFK/L, UGS0213CFK/P	472 zł	UGS02113PFK/L, UGS02113PFK/P	504 zł
14	Structural black	UGS0214CFK/L, UGS0214CFK/P	472 zł	UGS02114PFK/L, UGS02114PFK/P	504 zł
15	Dark str. graphite	UGS0215CFK/L, UGS0215CFK/P	472 zł	UGS02115PFK/L, UGS02115PFK/P	504 zł
16	Structural maroon	UGS0216CFK/L, UGS0216CFK/P	472 zł	UGS02116PFK/L, UGS02116PFK/P	504 zł
17	Gray metallic	UGS0217CFK/L, UGS0217CFK/P	472 zł	UGS02117PFK/L, UGS02117PFK/P	504 zł
18	Granite	UGS0218CFK/L, UGS0218CFK/P	472 zł	UGS02118PFK/L, UGS02118PFK/P	504 zł
19	Structural white	UGS0219CFK/L, UGS0219CFK/P	472 zł	UGS02119PFK/L, UGS02119PFK/P	504 zł
21	Matt white	UGS0221CFK/L, UGS0221CFK/P	472 zł	UGS02121PFK/L, UGS02121PFK/P	504 zł
24	Matt black	UGS0224CFK/L, UGS0224CFK/P	472 zł	UGS02124PFK/L, UGS02124PFK/P	504 zł



UNICO, RIGHT

EXCLUSIVE SETS

UNICO REGULATING

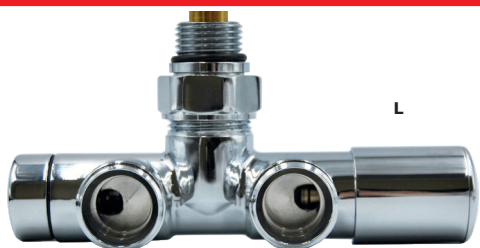

„Unico” regulating set, right or left, GZ 1/2" / GZ 3/4" x GZ 3/4", connection distance 50 mm.

The valve enables connection of an electric heater in the second riser of the heater.

Scope of delivery: „Unico” regulating connection, immersion tube, reducing nipple.

Correct installation of „Unico” valves: the drain is on the side of the control knob.

Additionally, it is possible to order sets with connectors for PEX or Cu. Couplings are an integral part of the valve (when ordering, add (PEX) or (Cu) at the end of the catalog number - example: 000M875A015/L(PEX)).

Important information Fittings (pages 70-71) are not included in the set price!

No.	Color	Type (angular, left/right)	Price
02	Chrome	000M875A002/L, 000M875A002/P	296 zł
03	Satin	000M875A003/L, 000M875A003/P	352 zł
04	Gold	000M875A004/L, 000M875A004/P	318 zł
05	Structural graphite	000M875A005/L, 000M875A005/P	318 zł
06	White	000M875A006/L, 000M875A006/P	296 zł
07	Glossy anth./Graph.	000M875A007/L, 000M875A007/P	318 zł
08	Nickel-grinded	000M875A008/L, 000M875A008/P	352 zł
09	Sand structural	000M875A009/L, 000M875A009/P	318 zł
10	Dark sand structural	000M875A010/L, 000M875A010/P	318 zł
11	Antique brass	000M875A011/L, 000M875A011/P	352 zł
12	Metallic graphite	000M875A012/L, 000M875A012/P	318 zł
13	Glossy black	000M875A013/L, 000M875A013/P	318 zł
14	Structural black	000M875A014/L, 000M875A014/P	318 zł
15	Dark str. graphite	000M875A015/L, 000M875A015/P	318 zł
16	Structural maroon	000M875A016/L, 000M875A016/P	318 zł
17	Gray metallic	000M875A017/L, 000M875A017/P	318 zł
18	Granite	000M875A018/L, 000M875A018/P	318 zł
19	Structural white	000M875A019/L, 000M875A019/P	318 zł
21	Matt white	000M875A021/L, 000M875A021/P	318 zł
24	Matt black	000M875A024/L, 000M875A024/P	318 zł



UNICO REGULATING, RIGHT

EXCLUSIVE SETS

VISION



„Vision” thermostatic set, axial, left or right, GZ ½” / GZ M22x1.5.

The set includes: „Vision” thermostatic valve, „Vision” shut-off valve, thermostatic head Prestige or Picco.

Additionally, it is possible to order sets with connectors for PEX or Cu. Couplings are an integral part of the valve (when ordering, add (PEX) or (Cu) at the end of the catalog number - example: VIGS0212C/FK (PEX)). You can also choose an external or internal thread - example: VIGS0205CFK/L (GW1/2).

Important information Fittings (pages 70-71) are not included in the set price!

No.	Color	With PRESTIGE thermostatic head	Price	With PICCO thermostatic head	Price
02	Chrome	VIGS0202CFK/L, VIGS0202CFK/P	318 zł	VIGS02102PFK/L, VIGS02102PFK/P	350 zł
03	Satin	VIGS0203CFK/L, VIGS0203CFK/P	374 zł	VIGS02103PFK/L, VIGS02103PFK/P	406 zł
04	Gold	VIGS0204CFK/L, VIGS0204CFK/P	340 zł	VIGS02104PFK/L, VIGS02104PFK/P	372 zł
05	Structural graphite	VIGS0205CFK/L, VIGS0205CFK/P	340 zł	VIGS02105PFK/L, VIGS02105PFK/P	372 zł
06	White	VIGS0206CFK/L, VIGS0206CFK/P	318 zł	VIGS02106PFK/L, VIGS02106PFK/P	350 zł
07	Glossy anth./Graph.	VIGS0207CFK/L, VIGS0207CFK/P	340 zł	VIGS02107PFK/L, VIGS02107PFK/P	372 zł
08	Nickel-grinded	VIGS0208CFK/L, VIGS0208CFK/P	374 zł	VIGS02108PFK/L, VIGS02108PFK/P	406 zł
09	Sand structural	VIGS0209CFK/L, VIGS0209CFK/P	340 zł	VIGS02109PFK/L, VIGS02109PFK/P	372 zł
10	Dark sand structural	VIGS0210CFK/L, VIGS0210CFK/P	340 zł	VIGS02110PFK/L, VIGS02110PFK/P	372 zł
11	Antique brass	VIGS0211CFK/L, VIGS0211CFK/P	374 zł	VIGS02111PFK/L, VIGS02111PFK/P	406 zł
12	Metallic graphite	VIGS0212CFK/L, VIGS0212CFK/P	340 zł	VIGS02112PFK/L, VIGS02112PFK/P	372 zł
13	Glossy black	VIGS0213CFK/L, VIGS0213CFK/P	340 zł	VIGS02113PFK/L, VIGS02113PFK/P	372 zł
14	Structural black	VIGS0214CFK/L, VIGS0214CFK/P	340 zł	VIGS02114PFK/L, VIGS02114PFK/P	372 zł
15	Dark str. graphite	VIGS0215CFK/L, VIGS0215CFK/P	340 zł	VIGS02115PFK/L, VIGS02115PFK/P	372 zł
16	Structural maroon	VIGS0216CFK/L, VIGS0216CFK/P	340 zł	VIGS02116PFK/L, VIGS02116PFK/P	372 zł
17	Gray metallic	VIGS0217CFK/L, VIGS0217CFK/P	340 zł	VIGS02117PFK/L, VIGS02117PFK/P	372 zł
18	Granite	VIGS0218CFK/L, VIGS0218CFK/P	340 zł	VIGS02118PFK/L, VIGS02118PFK/P	372 zł
19	Structural white	VIGS0219CFK/L, VIGS0219CFK/P	340 zł	VIGS02119PFK/L, VIGS02119PFK/P	372 zł
21	Matt white	VIGS0221CFK/L, VIGS0221CFK/P	340 zł	VIGS02121PFK/L, VIGS02121PFK/P	372 zł
24	Matt black	VIGS0224CFK/L, VIGS0224CFK/P	340 zł	VIGS02124PFK/L, VIGS02124PFK/P	372 zł

VISION, RIGHT, WITH PRESTIGE THERMOSTATIC HEAD



EXCLUSIVE SETS

VISION REGULATING



PEX connectors

„Vision” regulating set, axial left or right, GZ ½” / GZ M22x1,5.

Scope of delivery: „Vision” regulating valve, „Vision” shut-off valve.

Additionally, it is possible to order sets with connectors for PEX or Cu. Couplings are an integral part of the valve (when ordering, add (PEX) or (Cu) at the end of the catalog number - example: VIR06L (PEX)). You can also choose an external or internal thread - example: VIGS0214CFK/L(GW1/2).

Important information Fittings (pages 70-71) are not included in the set price!

No.	Color	Type (left/right)	Price
02	Chrome	VIR02L, VIR02P	222 zł
03	Satin	VIR03L, VIR03P	278 zł
04	Gold	VIR04L, VIR04P	244 zł
05	Structural graphite	VIR05L, VIR05P	244 zł
06	White	VIR06L, VIR06P	222 zł
07	Glossy anth./Graph.	VIR07L, VIR07P	244 zł
08	Nickel-grinded	VIR08L, VIR08P	278 zł
09	Sand structural	VIR09L, VIR09P	244 zł
10	Dark sand structural	VIR10L, VIR10P	244 zł
11	Antique brass	VIR11L, VIR11P	278 zł
12	Metallic graphite	VIR12L, VIR12P	244 zł
13	Glossy black	VIR13L, VIR13P	244 zł
14	Structural black	VIR14L, VIR14P	244 zł
15	Dark str. graphite	VIR15L, VIR15P	244 zł
16	Structural maroon	VIR16L, VIR16P	244 zł
17	Gray metallic	VIR17L, VIR17P	244 zł
18	Granite	VIR18L, VIR18P	244 zł
19	Structural white	VIR19L, VIR19P	244 zł
21	Matt white	VIR21L, VIR21P	244 zł
24	Matt black	VIR24L, VIR24P	244 zł



VISION REGULATING, RIGHT

EXCLUSIVE SETS

INTEGRA

PEX connectors



„Integra” thermostatic set, left or right, GZ ½” / M22x1,5.

Included: „Integra” thermostatic valve, „Integra” shut-off valve, „Prestige” thermostatic heads or „Picco” thermostatic head.

The valve body is integrated with the T-piece for connecting the electric heater to the radiator.

Additionally, it is possible to order sets with connectors for PEX or Cu. Couplings are an integral part of the valve (when ordering, add (PEX) or (Cu) at the end of the catalog number). Example: IGS0211PFK/L(PEX).

Important information Fittings (pages 70-71) are not included in the set price!

No.	Color	With PRESTIGE thermostatic head	Price	With PICCO thermostatic head	Price
02	Chrome	IGS0202CFK/L, IGS0202CFK/P	443 zł	IGS02102PFK/L, IGS02102PFK/P	475 zł
03	Satin	IGS0203CFK/L, IGS0203CFK/P	499 zł	IGS02103PFK/L, IGS02103PFK/P	531 zł
04	Gold	IGS0204CFK/L, IGS0204CFK/P	465 zł	IGS02104PFK/L, IGS02104PFK/P	497 zł
05	Structural graphite	IGS0205CFK/L, IGS0205CFK/P	465 zł	IGS02105PFK/L, IGS02105PFK/P	497 zł
06	White	IGS0206CFK/L, IGS0206CFK/P	443 zł	IGS02106PFK/L, IGS02106PFK/P	475 zł
07	Glossy anth./Graph.	IGS0207CFK/L, IGS0207CFK/P	465 zł	IGS02107PFK/L, IGS02107PFK/P	497 zł
08	Nickel-grinded	IGS0208CFK/L, IGS0208CFK/P	499 zł	IGS02108PFK/L, IGS02108PFK/P	531 zł
09	Sand structural	IGS0209CFK/L, IGS0209CFK/P	465 zł	IGS02109PFK/L, IGS02109PFK/P	497 zł
10	Dark sand structural	IGS0210CFK/L, IGS0210CFK/P	465 zł	IGS02110PFK/L, IGS02110PFK/P	497 zł
11	Antique brass	IGS0211CFK/L, IGS0211CFK/P	499 zł	IGS02111PFK/L, IGS02111PFK/P	531 zł
12	Metallic graphite	IGS0212CFK/L, IGS0212CFK/P	465 zł	IGS02112PFK/L, IGS02112PFK/P	497 zł
13	Glossy black	IGS0213CFK/L, IGS0213CFK/P	465 zł	IGS02113PFK/L, IGS02113PFK/P	497 zł
14	Structural black	IGS0214CFK/L, IGS0214CFK/P	465 zł	IGS02114PFK/L, IGS02114PFK/P	497 zł
15	Dark str. graphite	IGS0215CFK/L, IGS0215CFK/P	465 zł	IGS02115PFK/L, IGS02115PFK/P	497 zł
16	Structural maroon	IGS0216CFK/L, IGS0216CFK/P	465 zł	IGS02116PFK/L, IGS02116PFK/P	497 zł
17	Gray metallic	IGS0217CFK/L, IGS0217CFK/P	465 zł	IGS02117PFK/L, IGS02117PFK/P	497 zł
18	Granite	IGS0218CFK/L, IGS0218CFK/P	465 zł	IGS02118PFK/L, IGS02118PFK/P	497 zł
19	Structural white	IGS0219CFK/L, IGS0219CFK/P	465 zł	IGS02119PFK/L, IGS02119PFK/P	497 zł
21	Matt white	IGS0221CFK/L, IGS0221CFK/P	465 zł	IGS02121PFK/L, IGS02121PFK/P	497 zł
24	Matt black	IGS0224CFK/L, IGS0224CFK/P	465 zł	IGS02124PFK/L, IGS02124PFK/P	497 zł



INTEGRA, LEFT, WITH PICCO THERMOSTATIC HEAD

EXCLUSIVE SETS

INTEGRA REGULATING

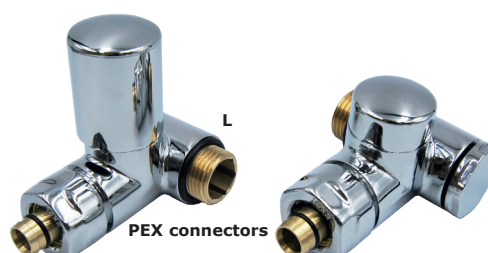

„Integra” control set, left or right, GZ ½” / GZ M22x1,5.

The set includes: „Integra” control valve, „Integra” shut-off valve.

The valve body is integrated with the tee, enabling the connection of an electric heater to the radiator.

Additionally, it is possible to order sets with connectors for PEX or Cu. Couplings are an integral part of the valve (when ordering, add (PEX) or (Cu) at the end of the catalog number). Example: IR24CFK/L(PEX).

Important information Fittings (pages 70-71) are not included in the set price!

No.	Color	Type (angular, left/right)	Price
02	Chrome	IR02CFK/L, IR02CFK/P	306 zł
03	Satin	IR03CFK/L, IR03CFK/P	413 zł
04	Gold	IR04CFK/L, IR04CFK/P	353 zł
05	Structural graphite	IR05CFK/L, IR05CFK/P	353 zł
06	White	IR06CFK/L, IR06CFK/P	306 zł
07	Glossy anth./Graph.	IR07CFK/L, IR07CFK/P	353 zł
08	Nickel-grinded	IR08CFK/L, IR08CFK/P	413 zł
09	Sand structural	IR09CFK/L, IR09CFK/P	353 zł
10	Dark sand structural	IR10CFK/L, IR10CFK/P	353 zł
11	Antique brass	IR11CFK/L, IR11CFK/P	413 zł
12	Metallic graphite	IR12CFK/L, IR12CFK/P	353 zł
13	Glossy black	IR13CFK/L, IR13CFK/P	353 zł
14	Structural black	IR14CFK/L, IR14CFK/P	353 zł
15	Dark str. graphite	IR15CFK/L, IR15CFK/P	353 zł
16	Structural maroon	IR16CFK/L, IR16CFK/P	353 zł
17	Gray metallic	IR17CFK/L, IR17CFK/P	353 zł
18	Granite	IR18CFK/L, IR18CFK/P	353 zł
19	Structural white	IR19CFK/L, IR19CFK/P	353 zł
21	Matt white	IR21CFK/L, IR21CFK/P	353 zł
24	Matt black	IR24CFK/L, IR24CFK/P	353 zł



INTEGRA, RIGHT, WITH BATHROOM HEATER (P. 72)

EXCLUSIVE SETS

QUATTRO

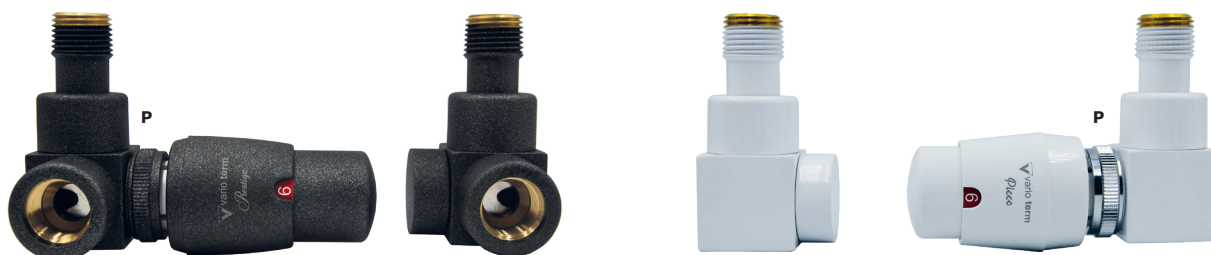

„Quattro” thermostatic set, axial left or right, GW ½” / MZ ½”.

The set includes: „Quattro” thermostatic valve, „Quattro” shut-off valve, „Prestige” thermostatic head or „Picco” thermostatic head.

Additionally, it is possible to order sets with connectors for PEX or Cu. The fittings are an integral part of the valve (when ordering, add (PEX) or (Cu) at the end of the catalog number). Example: QGS0208CFK/P(PEX).

No.	Color	With PRESTIGE thermostatic head	Price	With PICCO thermostatic head	Price
02	Chrome	QGS0202CFK/L, QGS0202CFK/P	465 zł	QGS02102PFK/L, QGS02102PFK/P	497 zł
03	Satin	QGS0203CFK/L, QGS0203CFK/P	523 zł	QGS02103PFK/L, QGS02103PFK/P	554 zł
04	Gold	QGS0204CFK/L, QGS0204CFK/P	489 zł	QGS02104PFK/L, QGS02104PFK/P	520 zł
05	Structural graphite	QGS0205CFK/L, QGS0205CFK/P	489 zł	QGS02105PFK/L, QGS02105PFK/P	520 zł
06	White	QGS0206CFK/L, QGS0206CFK/P	465 zł	QGS02106PFK/L, QGS02106PFK/P	497 zł
07	Glossy anth./Graph.	QGS0207CFK/L, QGS0207CFK/P	489 zł	QGS02107PFK/L, QGS02107PFK/P	520 zł
08	Nickel-grinded	QGS0208CFK/L, QGS0208CFK/P	523 zł	QGS02108PFK/L, QGS02108PFK/P	554 zł
09	Sand structural	QGS0209CFK/L, QGS0209CFK/P	489 zł	QGS02109PFK/L, QGS02109PFK/P	520 zł
10	Dark sand structural	QGS0210CFK/L, QGS0210CFK/P	489 zł	QGS02110PFK/L, QGS02110PFK/P	520 zł
11	Antique brass	QGS0211CFK/L, QGS0211CFK/P	523 zł	QGS02111PFK/L, QGS02111PFK/P	554 zł
12	Metallic graphite	QGS0212CFK/L, QGS0212CFK/P	489 zł	QGS02112PFK/L, QGS02112PFK/P	520 zł
13	Glossy black	QGS0213CFK/L, QGS0213CFK/P	489 zł	QGS02113PFK/L, QGS02113PFK/P	520 zł
14	Structural black	QGS0214CFK/L, QGS0214CFK/P	489 zł	QGS02114PFK/L, QGS02114PFK/P	520 zł
15	Dark str. graphite	QGS0215CFK/L, QGS0215CFK/P	489 zł	QGS02115PFK/L, QGS02115PFK/P	520 zł
16	Structural maroon	QGS0216CFK/L, QGS0216CFK/P	489 zł	QGS02116PFK/L, QGS02116PFK/P	520 zł
17	Gray metallic	QGS0217CFK/L, QGS0217CFK/P	489 zł	QGS02117PFK/L, QGS02117PFK/P	520 zł
18	Granite	QGS0218CFK/L, QGS0218CFK/P	489 zł	QGS02118PFK/L, QGS02118PFK/P	520 zł
19	Structural white	QGS0219CFK/L, QGS0219CFK/P	489 zł	QGS02119PFK/L, QGS02119PFK/P	520 zł
21	Matt white	QGS0221CFK/L, QGS0221CFK/P	489 zł	QGS02121PFK/L, QGS02121PFK/P	520 zł
24	Matt black	QGS0224CFK/L, QGS0224CFK/P	489 zł	QGS02124PFK/L, QGS02124PFK/P	520 zł

QUATTRO, LEFT, WITH PRESTIGE THERMOSTATIC HEAD



EXCLUSIVE SETS

QUATTRO REGULATING



„Quattro” adjustment set, axial, left or right, GW ½” / GZ ½”.
The set includes: „Quattro” control valve, „Quattro” shut-off valve.

Additionally, it is possible to order sets with connectors for PEX or Cu. Couplings are an integral part of the valve (when ordering, add (PEX) or (Cu) at the end of the catalog number). Example: QR08CFK/P(PEX).

No.	Color	Type (angular, left/right)	Price
02	Chrome	QR02CFK/L, QR02CFK/P	364 zł
03	Satin	QR03CFK/L, QR03CFK/P	408 zł
04	Gold	QR04CFK/L, QR04CFK/P	375 zł
05	Structural graphite	QR05CFK/L, QR05CFK/P	375 zł
06	White	QR06CFK/L, QR06CFK/P	364 zł
07	Glossy anth./Graph.	QR07CFK/L, QR07CFK/P	375 zł
08	Nickel-grinded	QR08CFK/L, QR08CFK/P	408 zł
09	Sand structural	QR09CFK/L, QR09CFK/P	375 zł
10	Dark sand structural	QR10CFK/L, QR10CFK/P	375 zł
11	Antique brass	QR11CFK/L, QR11CFK/P	408 zł
12	Metallic graphite	QR12CFK/L, QR12CFK/P	375 zł
13	Glossy black	QR13CFK/L, QR13CFK/P	375 zł
14	Structural black	QR14CFK/L, QR14CFK/P	375 zł
15	Dark str. graphite	QR15CFK/L, QR15CFK/P	375 zł
16	Structural maroon	QR16CFK/L, QR16CFK/P	375 zł
17	Gray metallic	QR17CFK/L, QR17CFK/P	375 zł
18	Granite	QR18CFK/L, QR18CFK/P	375 zł
19	Structural white	QR19CFK/L, QR19CFK/P	375 zł
21	Matt white	QR21CFK/L, QR21CFK/P	375 zł
24	Matt black	QR24CFK/L, QR24CFK/P	375 zł



QUATTRO REGULATING, LEFT

EXCLUSIVE SETS

LUX I



Thermostatic set „Lux I”, axial, left or right, GW ½” / GZ ½”.

Set includes: „Lux I” thermostatic valve, „Lux I” shut-off valve, „Prestige” thermostatic head or „Picco” thermostatic head.

Additionally, it is possible to order sets with connectors for PEX or Cu. Couplings are an integral part of the valve (when ordering, add (PEX) or (Cu) at the end of the catalog number, for example: LUX1GS0221C/L(PEX)).

No.	Color	With PRESTIGE thermostatic head	Price	With PICCO thermostatic head	Price
02	Chrome	LUX1GS0202CFK/L, LUX1GS0202CFK/P	454 zł	LUX1GS02102PFK/L, LUX1GS02102PFK/P	485 zł
03	Satin	LUX1GS0203CFK/L, LUX1GS0203CFK/P	499 zł	LUX1GS02103PFK/L, LUX1GS02103PFK/P	531 zł
04	Gold	LUX1GS0204CFK/L, LUX1GS0204CFK/P	465 zł	LUX1GS02104PFK/L, LUX1GS02104PFK/P	497 zł
05	Structural graphite	LUX1GS0205CFK/L, LUX1GS0205CFK/P	465 zł	LUX1GS02105PFK/L, LUX1GS02105PFK/P	497 zł
06	White	LUX1GS0206CFK/L, LUX1GS0206CFK/P	454 zł	LUX1GS02106PFK/L, LUX1GS02106PFK/P	485 zł
07	Glossy anth./Graph.	LUX1GS0207CFK/L, LUX1GS0207CFK/P	465 zł	LUX1GS02107PFK/L, LUX1GS02107PFK/P	497 zł
08	Nickel-grinded	LUX1GS0208CFK/L, LUX1GS0208CFK/P	499 zł	LUX1GS02108PFK/L, LUX1GS02108PFK/P	531 zł
09	Sand structural	LUX1GS0209CFK/L, LUX1GS0209CFK/P	465 zł	LUX1GS02109PFK/L, LUX1GS02109PFK/P	497 zł
10	Piaskowy ciemny str	LUX1GS0210CFK/L, LUX1GS0210CFK/P	465 zł	LUX1GS02110PFK/L, LUX1GS02110PFK/P	497 zł
11	Antique brass	LUX1GS0211CFK/L, LUX1GS0211CFK/P	499 zł	LUX1GS02111PFK/L, LUX1GS02111PFK/P	531 zł
12	Metallic graphite	LUX1GS0212CFK/L, LUX1GS0212CFK/P	465 zł	LUX1GS02112PFK/L, LUX1GS02112PFK/P	497 zł
13	Glossy black	LUX1GS0213CFK/L, LUX1GS0213CFK/P	465 zł	LUX1GS02113PFK/L, LUX1GS02113PFK/P	497 zł
14	Structural black	LUX1GS0214CFK/L, LUX1GS0214CFK/P	465 zł	LUX1GS02114PFK/L, LUX1GS02114PFK/P	497 zł
15	Dark str. graphite	LUX1GS0215CFK/L, LUX1GS0215CFK/P	465 zł	LUX1GS02115PFK/L, LUX1GS02115PFK/P	497 zł
16	Structural maroon	LUX1GS0216CFK/L, LUX1GS0216CFK/P	465 zł	LUX1GS02116PFK/L, LUX1GS02116PFK/P	497 zł
17	Gray metallic	LUX1GS0217CFK/L, LUX1GS0217CFK/P	465 zł	LUX1GS02117PFK/L, LUX1GS02117PFK/P	497 zł
18	Granite	LUX1GS0218CFK/L, LUX1GS0218CFK/P	465 zł	LUX1GS02118PFK/L, LUX1GS02118PFK/P	497 zł
19	Structural white	LUX1GS0219CFK/L, LUX1GS0219CFK/P	465 zł	LUX1GS02119PFK/L, LUX1GS02119PFK/P	497 zł
21	Matt white	LUX1GS0221CFK/L, LUX1GS0221CFK/P	465 zł	LUX1GS02121PFK/L, LUX1GS02121PFK/P	497 zł
24	Matt black	LUX1GS0224CFK/L, LUX1GS0224CFK/P	465 zł	LUX1GS02124PFK/L, LUX1GS02124PFK/P	497 zł



LUX I, LEFT, WITH PRESTIGE THERMOSTATIC HEAD

EXCLUSIVE SETS

LUX II



Thermostatic set „Lux II”, Angular, GW ½” / GZ ½”.

The set includes: „Lux II” thermostatic valve, „Lux II” shut-off valve, „Prestige” thermostatic head or „Picco” thermostatic head.

Additionally, it is possible to order sets with connectors for PEX or Cu. Couplings are an integral part of the valve (when ordering, add (PEX) or (Cu) at the end of the catalog number, for example: LUX2GS10212PFK(PEX)).

Important information! Fittings are not included in the price of the set!

No.	Color	With PRESTIGE thermostatic head	Price	With PICCO thermostatic head	Price
02	Chrome	LUX2GS0202CFK	409 zł	LUX2GS02102PFK	441 zł
03	Satin	LUX2GS0203CFK	465 zł	LUX2GS02103PFK	497 zł
04	Gold	LUX2GS0204CFK	431 zł	LUX2GS02104PFK	463 zł
05	Structural graphite	LUX2GS0205CFK	431 zł	LUX2GS02105PFK	463 zł
06	White	LUX2GS0206CFK	409 zł	LUX2GS02106PFK	441 zł
07	Glossy anth./Graph.	LUX2GS0207CFK	431 zł	LUX2GS02107PFK	463 zł
08	Nickel-grinded	LUX2GS0208CFK	465 zł	LUX2GS02108PFK	497 zł
09	Sand structural	LUX2GS0209CFK	431 zł	LUX2GS02109PFK	463 zł
10	Dark sand structural	LUX2GS0210CFK	431 zł	LUX2GS02110PFK	463 zł
11	Antique brass	LUX2GS0211CFK	465 zł	LUX2GS02111PFK	497 zł
12	Metallic graphite	LUX2GS0212CFK	431 zł	LUX2GS02112PFK	463 zł
13	Glossy black	LUX2GS0213CFK	431 zł	LUX2GS02113PFK	463 zł
14	Structural black	LUX2GS0214CFK	431 zł	LUX2GS02114PFK	463 zł
15	Dark str. graphite	LUX2GS0215CFK	431 zł	LUX2GS02115PFK	463 zł
16	Structural maroon	LUX2GS0216CFK	431 zł	LUX2GS02116PFK	463 zł
17	Gray metallic	LUX2GS0217CFK	431 zł	LUX2GS02117PFK	463 zł
18	Granite	LUX2GS0218CFK	431 zł	LUX2GS02118PFK	463 zł
19	Structural white	LUX2GS0219CFK	431 zł	LUX2GS02119PFK	463 zł
21	Matt white	LUX2GS0221CFK	431 zł	LUX2GS02121PFK	463 zł
24	Matt black	LUX2GS0224CFK	431 zł	LUX2GS02124PFK	463 zł

LUX II, ANGULAR, WITH PRESTIGE THERMOSTATIC HEAD

EXCLUSIVE SETS

PREMIUM EXCLUSIVE



„Premium Exclusive“ thermostatic set, angular version, GW $\frac{3}{4}$ " / M22x1.5 external thread.

The set includes: „Premium Exclusive“ thermostatic valve, „Prestige“ / „Picco“ thermostatic head, chrome-plated brass nipples.

Important information! Fittings (pages 70-71) are not included in the set price!

No.	Color	With PRESTIGE thermostatic head	Price	With PICCO thermostatic head	Price
02	Chrome	PREGS0202C/FK	250 zł	PREGS02102P/FK	282 zł
03	Satin	PREGS0203C/FK	306 zł	PREGS02103P/FK	338 zł
04	Gold	PREGS0204C/FK	272 zł	PREGS02104P/FK	304 zł
05	Structural graphite	PREGS0205C/FK	272 zł	PREGS02105P/FK	304 zł
06	White	PREGS0206C/FK	250 zł	PREGS02106P/FK	282 zł
07	Glossy anth./Graph.	PREGS0207C/FK	272 zł	PREGS02107P/FK	304 zł
08	Nickel-grinded	PREGS0208C/FK	306 zł	PREGS02108P/FK	338 zł
09	Sand structural	PREGS0209C/FK	272 zł	PREGS02109P/FK	304 zł
10	Dark sand structural	PREGS0210C/FK	272 zł	PREGS02110P/FK	304 zł
11	Antique brass	PREGS0211C/FK	306 zł	PREGS02111P/FK	338 zł
12	Metallic graphite	PREGS0212C/FK	272 zł	PREGS02112P/FK	304 zł
13	Glossy black	PREGS0213C/FK	272 zł	PREGS02113P/FK	304 zł
14	Structural black	PREGS0214C/FK	272 zł	PREGS02114P/FK	304 zł
15	Dark str. graphite	PREGS0215C/FK	272 zł	PREGS02115P/FK	304 zł
16	Bordowy struktur.	PREGS0216C/FK	272 zł	PREGS02116P/FK	304 zł
17	Gray metallic	PREGS0217C/FK	272 zł	PREGS02117P/FK	304 zł
18	Granite	PREGS0218C/FK	272 zł	PREGS02118P/FK	304 zł
19	Structural white	PREGS0219C/FK	272 zł	PREGS02119P/FK	304 zł
21	Matt white	PREGS0221C/FK	272 zł	PREGS02121P/FK	304 zł
24	Matt black	PREGS0224C/FK	272 zł	PREGS02124P/FK	304 zł

PREMIUM EXCLUSIVE, ANGULAR, WITH PRESTIGE THERMOSTATIC HEAD

COLLECTION ALL IN ONE GLAMOUR



RTL SETS

Underfloor heating has many advantages: the heated floor lasts for a long time, the floors in the bathroom dry quickly, and the method of heat distribution from such heating allows you to reduce the temperature in the room by around 2° while maintaining a sense of thermal comfort. In addition, heating is considered the best for our health.

Underfloor heating is a very good solution, but if the area of rooms designed for this type of installation is small, its installation may be unprofitable. Sometimes users just want to „warm” the floor from cold material, such as stoneware, despite the use of traditional radiators. It is worth considering another option: integrated heating.



Linia produktów do ogrzewania zintegrowanego

The principle of its operation is to limit the water temperature at the heater return and / or in the underfloor heating loop (**up to 15m²**). The use of the above limiter will maintain a constant temperature of the heating medium return in the range from 10°C to 50°C, additionally eliminating the need to install a mixing valve and an additional circulation pump.

Operating principle - connections, for examples of applications:

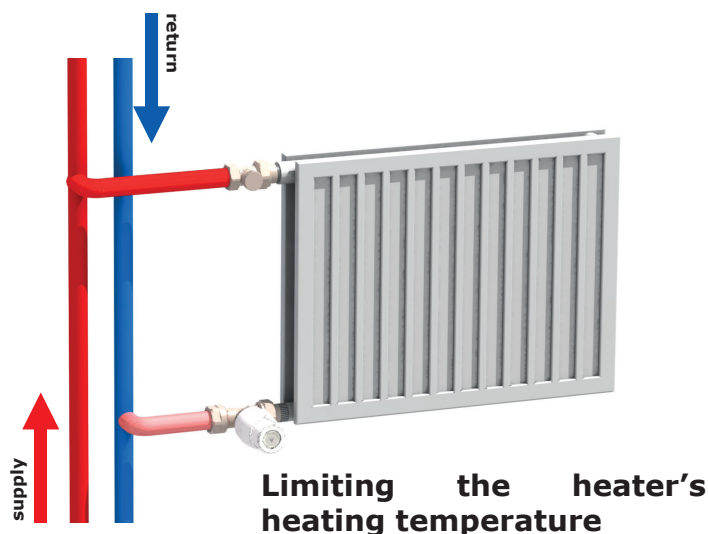
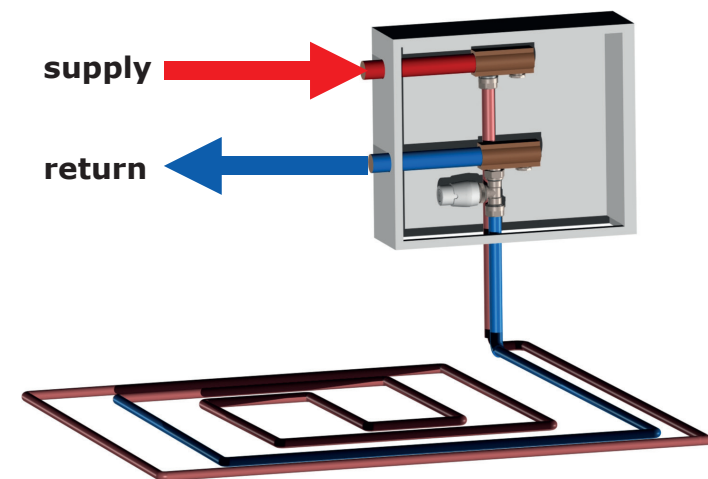

Return temperature limitation

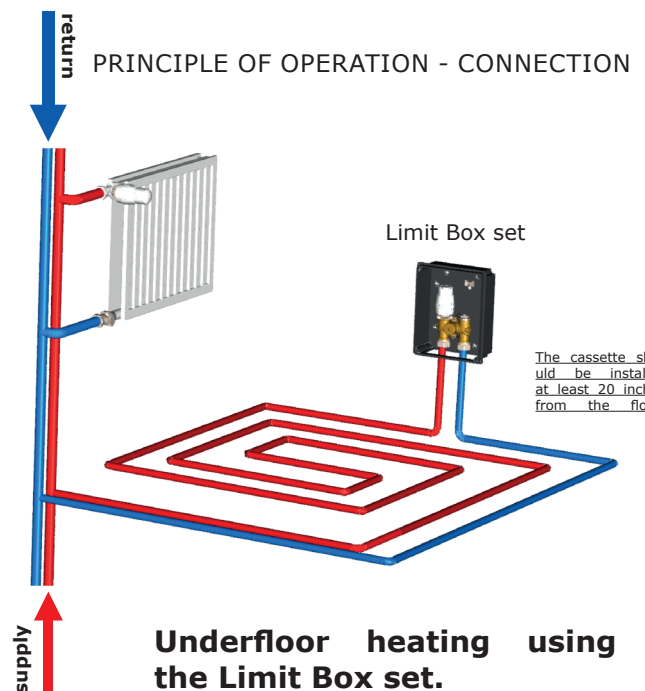

RTL SETS

LIMIT BOX OF TYPE „T”



Covered RTL head and uncovered Picco th. head ZKTRTL06 380 zł
 „Limit Box RTL” set with GZ ¾ output for PEX / Cu adapters. It has been designed to regulate the temperature of small surfaces of underfloor heating (thanks to the RTL head), and thanks to an additional classic thermostatic head, we also control the ambient temperature.
 The set includes: „Limit Box RTL” integrated valve, „Prestige RTL” head, „Picco” thermostatic head, LimitBox, setting key, PEX 16x2 / GZ connectors ¾.

LIMIT BOX OF TYPE „O”



Uncovered RTL head ZKORTL06 300 zł
 „Limit Box RTL” set with GZ ¾ output for PEX / Cu adapters. It has been designed to regulate the temperature of small areas of underfloor heating. It is perfect for connecting a newly made underfloor heating installation, but also to an existing radiator installation.
 The set includes: „Limit Box RTL” integrated valve, „Prestige RTL” head, Limit Box, setting key, PEX 16x2 / GZ connectors ¾.

LIMIT BOX OF TYPE „Z”



Covered RTL head ZKZRTL06 272 zł
 „Limit Box RTL” set with GZ ¾ output for PEX / Cu adapters. It has been designed to regulate the temperature of small areas of underfloor heating. It is perfect for connecting a newly made underfloor heating installation, but also to an existing radiator installation.
 The set includes: „Limit Box RTL” integrated valve, „Prestige RTL” head, Limit Box, setting key, PEX 16x2 / GZ connectors ¾.

STANDARD RTL



Nickel ZRTL06/K, ZRTL06/P 137 zł
 RTL Set STANDRAD version (straight or angular), with connection for Pex/Cu adapters, designed for limiting the temperature on the return side of the radiator or for temperature regulation on small floor heating installations (up to 15m²).
 The set includes: „Standard RTL” valve, „Prestige RTL” head.

RTL SETS

In order to receive an offer, please contact the office or the Vario Term Export Department.

TWINS RTL



Set for underfloor heating „Twins RTL”, right or left, GZ $\frac{3}{4}$ " / GW $\frac{3}{4}$ ". The distance between the connections to the installation is 50 mm.

The kit is used to limit the return temperature of the radiator or to regulate the temperature for small surfaces of underfloor heating (up to 15 m²).

The set includes: „Twins RTL” connection, „Prestige RTL” head.

UNICO RTL

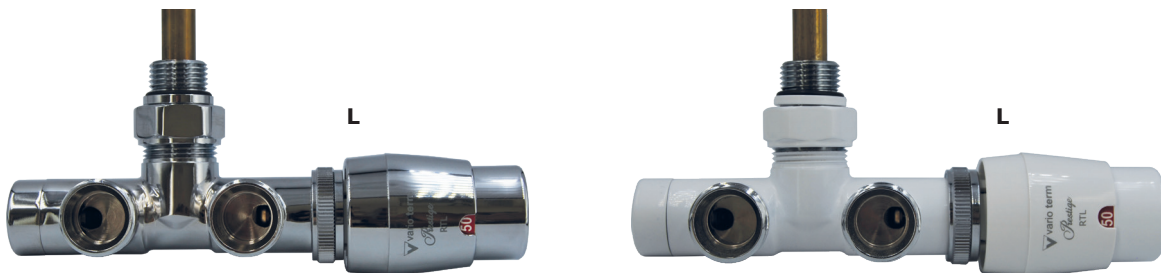

Set for underfloor heating „Unico RTL”, right or left, GZ $\frac{1}{2}$ " / GZ $\frac{3}{4}$ " x GZ $\frac{3}{4}$ ". The distance between the connections to the installation is 50 mm.

Specially designed for radiators that allow the use of an electric heater. The kit is used to limit the return temperature of the radiator or to regulate the temperature for small surfaces of underfloor heating (up to 15 m²).

The set includes: „Unico RTL” connection, immersion tube, „Prestige RTL” head.



TWINS RTL, LEFT, WITH PRESTIGE RTL HEAD

RTL SETS

In order to receive an offer, please contact the office or the Vario Term Export Department.

VISION RTL



Set for underfloor heating „Vision RTL”, right or left, GZ ½” / GZ M22x1.5.

The kit is used to limit the return temperature of the radiator or to regulate the temperature for small surfaces of underfloor heating (up to 15 m²).

The set includes: „Vision RTL” supply valve, „Vision RTL” shut-off valve, „Prestige RTL” head.

LUX II RTL

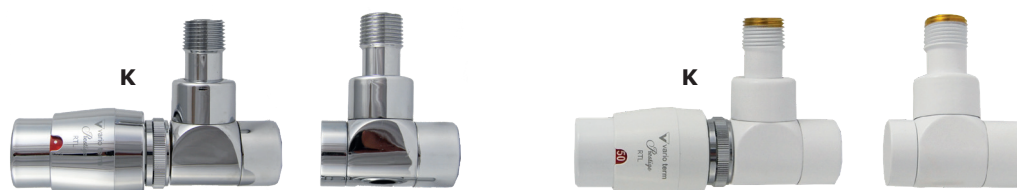

Set for underfloor heating „Lux II RTL”, angular, GW ½” / GZ ½”.

The kit is used to limit the return temperature of the radiator or to regulate the temperature for small surfaces of underfloor heating (up to 15 m²).

The set includes: „Lux II RTL” supply valve, „Lux II RTL” shut-off valve, „Prestige RTL” head.



LUX II RTL, ANGULAR, WITH PRESTIGE RTL HEAD

BRASS HYDRO-CYCLONIC MAGNETIC FILTER

Find out more...
from the Vario Term Export Department or
...on the website www.brassform.pl



**POWERFUL
NEODYMIUM MAGNET**
10.500+ Gauss

360° FITTINGS
for installation on
several orientation &
connection pipework.

STAINLESS STEEL
filtering Cartridge AISI 304



New



TRANSPARENT POLYSULFONE
cover for visual control

**GREEK
100%
PRODUCT**



VRC SYSTEM

VARIO REMOTE CONTROL SYSTEM - REMOTE CONTROLLED THERMOSTATIC HEADS

The VRC system is a mobile thermostat on a smartphone that allows remote control and temperature control in individual rooms of your home, flat or company.

In contrast to traditional thermostats, the VRC system allows you to program the temperature in individual rooms separately. It gives you the opportunity to lower the temperature in the rooms you are temporarily not using. In each of the rooms you can also define other setpoint temperatures: Lowered, Comfortable and Elevated.

Thanks to the PID algorithm in temperature control, we can achieve high accuracy in setting the room temperature. The VRC System software optimizes the operation of radiators for maximum comfort with a minimum of thermal energy consumption.

By installing the VRC system thermostatic valves on radiators, we can get a better use of thermal energy from the hot water supplied to the radiator. In addition, individually set heating times and temperature values for each room reduce the amount of thermal energy consumed. Thanks to this, we can save up to 30% of the thermal energy used in the apartment.



When do you get up in the morning...



When you eat breakfast...



When you are not at home...



When you sleep...

System VRC

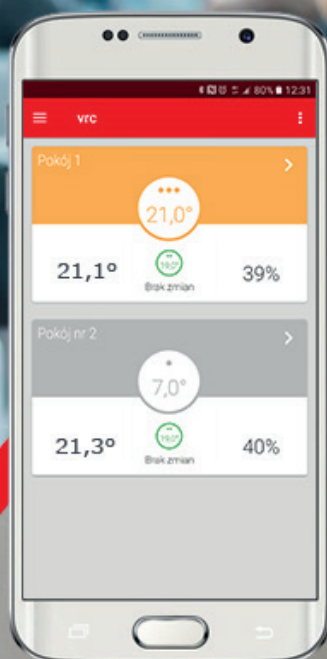

<https://system-vrc.pl/>

63

SYSTEM VRC

VRC STARTER PACK

White

VRC06

1 484 zł

The Vario Remote Control system allows you to set the temperature in each room separately. VRC thermostatic heads can be installed independently of the hot water supply to the radiator. The installation is simple and does not require draining water from the C.O network. You can also program the operation of heating devices in rooms at specific times for each day of the week. The package can be used to install additional devices from the VRC system.

The set includes: VRC control panel, 2 x VRC thermostatic head, 2 x battery, VRC temperature and humidity sensor.



CENTRAL

White

M643B003001

721 zł

The control panel is part of the heat management system, designed to control the C.O boiler. (eg gas, oil, coal), which is equipped with a thermostat input. The control panel controls 230VAC thermoelectric actuators based on the radio temperature sensors in the VRC thermostatic heads. The control panel supports up to 12 heating zones.



TEMPERATURE AND HUMIDITY SENSOR

White

M643B002001

233 zł

Wireless temperature and humidity sensor is a device that allows you to precisely control the temperature in a specific zone of the room. In addition, the sensor measures the humidity, which gives us the knowledge if the heating is not too dry. The sensor sends information about measurements to the controller via radio to the VRC system.



VRC THERMOSTATIC HEAD



The thermostatic head makes it possible to manage the temperature in each room separately. The head is adapted to be installed on standard valves with a thread for the M30/1.5 head supplying hot water to radiators. The head has a built-in temperature sensor and an actuator that opens or closes the water supply depending on the programmer settings. The head communicates via radio with the VRC control panel, which transmits to the head the set temperature from the programmer and / or the room temperature from the external sensor.

The thermostatic head can be equipped with an anti-theft protection and temperature protection, e.g. from 16°C. In order to receive an offer, please contact the office or the Vario Term Export Department.

No.	Color	Type	Price
05	Structural graphite	M643B001005	336 zł
06	White	M643B001006	280 zł
07	Glossy anth./Graph.	M643B001007	336 zł
13	Glossy black	M643B001013	336 zł
14	Structural black	M643B001014	336 zł



MASKING ACCESSORIES

SINGLE MASKING ROSETTE

Round, flat masking rosette. It is available in three configurations: 1/2" (Ø 22 mm), 3/4" (Ø 25 mm), 3/8" (Ø 16 mm).

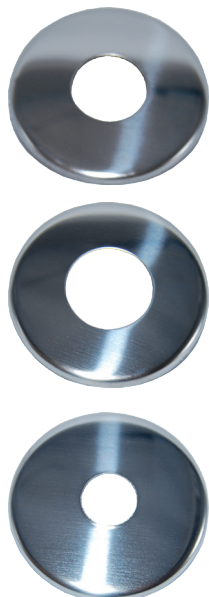

No.	Color	1/2" (Ø 22 mm)	3/4" (Ø 25 mm)	3/8" (Ø 16 mm)	Price
02	Chrome	000M820A002	000M821A002	000M822A002	21 zł
03	Satin	000M820A003	000M821A003	000M822A003	32 zł
04	Gold	000M820A004	000M821A004	000M822A004	27 zł
05	Structural graphite	000M820A005	000M821A005	000M822A005	27 zł
06	White	000M820A006	000M821A006	000M822A006	21 zł
07	Glossy anth./Graph.	000M820A007	000M821A007	000M822A007	27 zł
08	Nickel-grinded	000M820A008	000M821A008	000M822A008	32 zł
09	Sand structural	000M820A009	000M821A009	000M822A009	27 zł
10	Dark sand structural	000M820A010	000M821A010	000M822A010	27 zł
11	Antique brass	000M820A011	000M821A011	000M822A011	32 zł
12	Metallic graphite	000M820A012	000M821A012	000M822A012	27 zł
13	Glossy black	000M820A013	000M821A013	000M822A013	27 zł
14	Structural black	000M820A014	000M821A014	000M822A014	27 zł
15	Dark str. graphite	000M820A015	000M821A015	000M822A015	27 zł
16	Structural maroon	000M820A016	000M821A016	000M822A016	27 zł
17	Gray metallic	000M820A017	000M821A017	000M822A017	27 zł
18	Granite	000M820A018	000M821A018	000M822A018	27 zł
19	Structural white	000M820A019	000M821A019	000M822A019	27 zł
21	Matt white	000M820A021	000M821A021	000M822A021	27 zł
24	Matt black	000M820A024	000M821A024	000M822A024	27 zł

MASKING SET WITH SINGLE ROSETTE

The set includes: 2 x rosette 3/4"**, 2 x silicone gaskets**, 2 x masking sleeve 50 mm*, 2 x adapter / compression fitting PEX / Cu / GZ / GW.

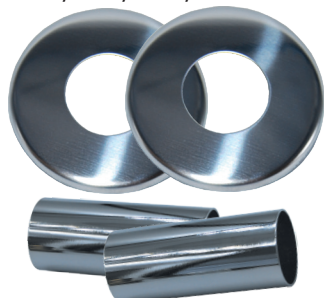

Valve fittings:

VISION,
INTEGRA,
PREMIUM EXCLUSIVE.



No.	Color	PEX	Cu	GZ (PEX)	GZ (Cu)	Price
02	Chrome	ZMR1P16xM2202	ZMR1M15xM2202	ZMR1GZ1/2x1602	ZMR1GZ1/2x1502	100 zł
03	Satin	ZMR1P16xM2203	ZMR1M15xM2203	ZMR1GZ1/2x1603	ZMR1GZ1/2x1503	133 zł
04	Gold	ZMR1P16xM2204	ZMR1M15xM2204	ZMR1GZ1/2x1604	ZMR1GZ1/2x1504	110 zł
05	Structural graphite	ZMR1P16xM2205	ZMR1M15xM2205	ZMR1GZ1/2x1605	ZMR1GZ1/2x1505	110 zł
06	White	ZMR1P16xM2206	ZMR1M15xM2206	ZMR1GZ1/2x1606	ZMR1GZ1/2x1506	100 zł
07	Glossy anth./Graph.	ZMR1P16xM2207	ZMR1M15xM2207	ZMR1GZ1/2x1607	ZMR1GZ1/2x1507	110 zł
08	Nickel-grinded	ZMR1P16xM2208	ZMR1M15xM2208	ZMR1GZ1/2x1608	ZMR1GZ1/2x1508	133 zł
09	Sand structural	ZMR1P16xM2209	ZMR1M15xM2209	ZMR1GZ1/2x1609	ZMR1GZ1/2x1509	110 zł
10	Piaskowy ciemny str	ZMR1P16xM2210	ZMR1M15xM2210	ZMR1GZ1/2x1610	ZMR1GZ1/2x1510	110 zł
11	Antique brass	ZMR1P16xM2211	ZMR1M15xM2211	ZMR1GZ1/2x1611	ZMR1GZ1/2x1511	133 zł
12	Metallic graphite	ZMR1P16xM2212	ZMR1M15xM2212	ZMR1GZ1/2x1612	ZMR1GZ1/2x1512	110 zł
13	Glossy black	ZMR1P16xM2213	ZMR1M15xM2213	ZMR1GZ1/2x1613	ZMR1GZ1/2x1513	110 zł
14	Structural black	ZMR1P16xM2214	ZMR1M15xM2214	ZMR1GZ1/2x1614	ZMR1GZ1/2x1514	110 zł
15	Ciemny grafit strukt	ZMR1P16xM2215	ZMR1M15xM2215	ZMR1GZ1/2x1615	ZMR1GZ1/2x1515	110 zł
16	Bordowy struktur.	ZMR1P16xM2216	ZMR1M15xM2216	ZMR1GZ1/2x1616	ZMR1GZ1/2x1516	110 zł
17	Gray metallic	ZMR1P16xM2217	ZMR1M15xM2217	ZMR1GZ1/2x1617	ZMR1GZ1/2x1517	110 zł
18	Granite	ZMR1P16xM2218	ZMR1M15xM2218	ZMR1GZ1/2x1618	ZMR1GZ1/2x1518	110 zł
19	Structural white	ZMR1P16xM2219	ZMR1M15xM2219	ZMR1GZ1/2x1619	ZMR1GZ1/2x1519	110 zł
21	Matt white	ZMR1P16xM2221	ZMR1M15xM2221	ZMR1GZ1/2x1621	ZMR1GZ1/2x1521	110 zł
24	Matt black	ZMR1P16xM2224	ZMR1M15xM2224	ZMR1GZ1/2x1624	ZMR1GZ1/2x1524	110 zł

* Different sleeve lengths and rosettes configuration for individual orders.
** Silicone gaskets included with 3/4" rosettes only.

MASKING ACCESSORIES

DOUBLE MASKING ROSETTE

No.	Color	1/2" (Ø 22 mm)	3/4" (Ø 25 mm)	3/8" (Ø 16 mm)	Price
02	Chrome	000M823A002	000M823A202	000M823A102	34 zł
03	Satin	000M823A003	000M823A203	000M823A103	46 zł
04	Gold	000M823A004	000M823A204	000M823A104	39 zł
05	Structural graphite	000M823A005	000M823A205	000M823A105	39 zł
06	White	000M823A006	000M823A206	000M823A106	34 zł
07	Antracyt / Grafit błysz.	000M823A007	000M823A207	000M823A107	39 zł
08	Nickel-grinded	000M823A008	000M823A208	000M823A108	46 zł
09	Sand structural	000M823A009	000M823A209	000M823A109	39 zł
10	Piaskowy ciemny strukt.	000M823A010	000M823A210	000M823A110	39 zł
11	Antique brass	000M823A011	000M823A211	000M823A111	46 zł
12	Metallic graphite	000M823A012	000M823A212	000M823A112	39 zł
13	Glossy black	000M823A013	000M823A213	000M823A113	39 zł
14	Structural black	000M823A014	000M823A214	000M823A114	39 zł
15	Ciemny grafit struktur.	000M823A015	000M823A215	000M823A115	39 zł
16	Structural maroon	000M823A016	000M823A216	000M823A116	39 zł
17	Gray metallic	000M823A017	000M823A217	000M823A117	39 zł
18	Granite	000M823A018	000M823A218	000M823A118	39 zł
19	Structural white	000M823A019	000M823A219	000M823A119	39 zł
21	Matt white	000M823A021	000M823A221	000M823A121	39 zł
24	Matt black	000M823A024	000M823A224	000M823A124	39 zł

Double flat masking rosette for valves with a spacing of 50 mm round. It is available in three configurations: 1/2" (Ø 22 mm), 3/4" (Ø 25 mm), 3/8" (Ø 16 mm).



MASKING SET WITH DOUBLE ROSETTE

No.	Color	PEX	Cu	Price
02	Chrome	ZMR2P16x3/402	ZMR2M15x3/402	100 zł
03	Satin	ZMR2P16x3/403	ZMR2M15x3/403	133 zł
04	Gold	ZMR2P16x3/404	ZMR2M15x3/404	110 zł
05	Structural graphite	ZMR2P16x3/405	ZMR2M15x3/405	110 zł
06	White	ZMR2P16x3/406	ZMR2M15x3/406	100 zł
07	Glossy anth./Graph.	ZMR2P16x3/407	ZMR2M15x3/407	110 zł
08	Nickel-grinded	ZMR2P16x3/408	ZMR2M15x3/408	133 zł
09	Sand structural	ZMR2P16x3/409	ZMR2M15x3/409	110 zł
10	Dark sand structural	ZMR2P16x3/410	ZMR2M15x3/410	110 zł
11	Antique brass	ZMR2P16x3/411	ZMR2M15x3/411	133 zł
12	Metallic graphite	ZMR2P16x3/412	ZMR2M15x3/412	110 zł
13	Glossy black	ZMR2P16x3/413	ZMR2M15x3/413	110 zł
14	Structural black	ZMR2P16x3/414	ZMR2M15x3/414	110 zł
15	Dark str. graphite	ZMR2P16x3/415	ZMR2M15x3/415	110 zł
16	Structural maroon	ZMR2P16x3/416	ZMR2M15x3/416	110 zł
17	Gray metallic	ZMR2P16x3/417	ZMR2M15x3/417	110 zł
18	Granite	ZMR2P16x3/418	ZMR2M15x3/418	110 zł
19	Structural white	ZMR2P16x3/419	ZMR2M15x3/419	110 zł
21	Matt white	ZMR2P16x3/421	ZMR2M15x3/421	110 zł
24	Matt black	ZMR2P16x3/424	ZMR2M15x3/424	110 zł

The set includes:
 1 x double rosette 3/4"*,
 2 x silicone gaskets **,
 2 x masking sleeve 50mm*,
 2 x PEX or Cu compression fittings.



* Different sleeve lengths and rosettes configuration for individual orders.

** Silicone gaskets included with 3/4" rosettes only.

MASKING ACCESSORIES

DOUBLE RECTANGULAR MASKING ROSETTE

Double, rectangular, flat masking rosette for valves with a spacing of 50 mm.

It is available in two configurations: 1/2" (Ø 22 mm) and 3/4" (Ø 25 mm).



No.	Color	1/2" (Ø 22 mm)	3/4" (Ø 25 mm)	Price
02	Chrome	000M825A002	000M825A202	40 zł
03	Satin	000M825A003	000M825A203	52 zł
04	Gold	000M825A004	000M825A204	47 zł
05	Structural graphite	000M825A005	000M825A205	47 zł
06	White	000M825A006	000M825A206	40 zł
07	Glossy anth./Graph.	000M825A007	000M825A207	47 zł
08	Nickel-grinded	000M825A008	000M825A208	52 zł
09	Sand structural	000M825A009	000M825A209	47 zł
10	Dark sand structural	000M825A010	000M825A210	47 zł
11	Antique brass	000M825A011	000M825A211	52 zł
12	Metallic graphite	000M825A012	000M825A212	47 zł
13	Glossy black	000M825A013	000M825A213	47 zł
14	Structural black	000M825A014	000M825A214	47 zł
15	Dark str. graphite	000M825A015	000M825A215	47 zł
16	Structural maroon	000M825A016	000M825A216	47 zł
17	Gray metallic	000M825A017	000M825A217	47 zł
18	Granite	000M825A018	000M825A218	47 zł
19	Structural white	000M825A019	000M825A219	47 zł
21	Matt white	000M825A021	000M825A221	47 zł
24	Matt black	000M825A024	000M825A224	47 zł

MASKING SET WITH A DOUBLE RECTANGULAR ROSETTE

The set includes: 1 x double rectangular rosette 3/4" *, 2 x silicone gaskets **, 2 x masking sleeve 50 mm *, 2 x PEX or Cu compression fittings.

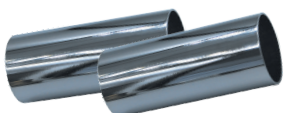

No.	Color	PEX	CU	Price
02	Chrome	ZMRP2P16x3/402	ZMRP2M15x3/402	105 zł
03	Satin	ZMRP2P16x3/403	ZMRP2M15x3/403	138 zł
04	Gold	ZMRP2P16x3/404	ZMRP2M15x3/404	116 zł
05	Structural graphite	ZMRP2P16x3/405	ZMRP2M15x3/405	116 zł
06	White	ZMRP2P16x3/406	ZMRP2M15x3/406	105 zł
07	Glossy anth./Graph.	ZMRP2P16x3/407	ZMRP2M15x3/407	116 zł
08	Nickel-grinded	ZMRP2P16x3/408	ZMRP2M15x3/408	138 zł
09	Sand structural	ZMRP2P16x3/409	ZMRP2M15x3/409	116 zł
10	Dark sand structural	ZMRP2P16x3/410	ZMRP2M15x3/410	116 zł
11	Antique brass	ZMRP2P16x3/411	ZMRP2M15x3/411	138 zł
12	Metallic graphite	ZMRP2P16x3/412	ZMRP2M15x3/412	116 zł
13	Glossy black	ZMRP2P16x3/413	ZMRP2M15x3/413	116 zł
14	Structural black	ZMRP2P16x3/414	ZMRP2M15x3/414	116 zł
15	Dark str. graphite	ZMRP2P16x3/415	ZMRP2M15x3/415	116 zł
16	Structural maroon	ZMRP2P16x3/416	ZMRP2M15x3/416	116 zł
17	Gray metallic	ZMRP2P16x3/417	ZMRP2M15x3/417	116 zł
18	Granite	ZMRP2P16x3/418	ZMRP2M15x3/418	116 zł
19	Structural white	ZMRP2P16x3/419	ZMRP2M15x3/419	116 zł
21	Matt white	ZMRP2P16x3/421	ZMRP2M15x3/421	116 zł
24	Matt black	ZMRP2P16x3/424	ZMRP2M15x3/424	116 zł

* Different sleeve lengths and rosettes configuration for individual orders.

** Silicone gaskets included with 3/4" rosettes only.

CONNECTION ACCESSORIES

EXTENSION

No.	Color	GZ $\frac{1}{2}$ " x GZ $\frac{1}{2}$ "	GZ $\frac{1}{2}$ " x M22x1,5GW	GZ $\frac{1}{2}$ " x GW $\frac{1}{2}$ "	Price
02	Chrome	000M830A0250	000M831A0250	000M832A0250	35 zł
03	Satin	000M830A0350	000M831A0350	000M832A0350	47 zł
04	Gold	000M830A0450	000M831A0450	000M832A0450	41 zł
05	Structural graphite	000M830A0550	000M831A0550	000M832A0550	41 zł
06	White	000M830A0650	000M831A0650	000M832A0650	35 zł
07	Glossy anth./Graph.	000M830A0750	000M831A0750	000M832A0750	41 zł
08	Nickel-grinded	000M830A0850	000M831A0850	000M832A0850	47 zł
09	Sand structural	000M830A0950	000M831A0950	000M832A0950	41 zł
10	Dark sand structural	000M830A1050	000M831A1050	000M832A1050	41 zł
11	Antique brass	000M830A1150	000M831A1150	000M832A1150	47 zł
12	Metallic graphite	000M830A1250	000M831A1250	000M832A1250	41 zł
13	Glossy black	000M830A1350	000M831A1350	000M832A1350	41 zł
14	Czarny struktur.	000M830A1450	000M831A1450	000M832A1450	41 zł
15	Dark str. graphite	000M830A1550	000M831A1550	000M832A1550	41 zł
16	Bordowy struktur.	000M830A1650	000M831A1650	000M832A1650	41 zł
17	Gray metallic	000M830A1750	000M831A1750	000M832A1750	41 zł
18	Granite	000M830A1850	000M831A1850	000M832A1850	41 zł
19	Structural white	000M830A1950	000M831A1950	000M832A1950	41 zł
21	Matt white	000M830A2150	000M831A2150	000M832A2150	41 zł
24	Matt black	000M830A2450	000M831A2450	000M832A2450	41 zł

Extensions 50 mm* long in configurations: GZ $\frac{1}{2}$ " x GZ $\frac{1}{2}$ ", GZ $\frac{1}{2}$ " x 22x1.5 GW, GZ $\frac{1}{2}$ " x GW $\frac{1}{2}$ " for valves with installation thread $\frac{1}{2}$ ".

Extensions GZ $\frac{1}{2}$ " x GZ $\frac{1}{2}$ " and GZ $\frac{1}{2}$ " x GW $\frac{1}{2}$ " adapted to the valve:

AXI ELEGANT, BALL, ELEGANT, MASTER, ROYAL, SWING, LUX I, LUX II, QUATTRO.



Extension GZ $\frac{1}{2}$ " x M22x1.5 GW adapted to valves: PREMIUM EXCLUSIVE, VISION, INTEGRA.



COVERING SLEEVE 50 MM

No.	Color	50 mm	Price
02	Chrome	000M840A0250	17 zł
03	Satin	000M840A0350	28 zł
04	Gold	000M840A0450	22 zł
05	Structural graphite	000M840A0550	22 zł
06	White	000M840A0650	17 zł
07	Glossy anth./Graph.	000M840A0750	22 zł
08	Nickel-grinded	000M840A0850	28 zł
09	Sand structural	000M840A0950	22 zł
10	Dark sand structural	000M840A1050	22 zł
11	Antique brass	000M840A1150	28 zł
12	Metallic graphite	000M840A1250	22 zł
13	Glossy black	000M840A1350	22 zł
14	Structural black	000M840A1450	22 zł
15	Dark str. graphite	000M840A1550	22 zł
16	Structural maroon	000M840A1650	22 zł
17	Gray metallic	000M840A1750	22 zł
18	Granite	000M840A1850	22 zł
19	Structural white	000M840A1950	22 zł
21	Matt white	000M840A2150	22 zł
24	Matt black	000M840A2450	22 zł

Masking sleeve 50 mm* (Ø 21 mm) for masking PEX (16x2) or CU (15x1) pipes. Installation can be carried out before connecting the radiator to the installation.



* Standard lengths are shown in the table.
Manufacture of other lengths for individual orders.

CONNECTION ACCESSORIES

CONNECTION / CLAMPING ADAPTER M22x1,5

The connector is intended for connection with the valve central heating system:

VISION,
INTEGRA,
PREMIUM EXCLUSIVE.

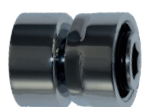

No.	Color	PEX	Cu	Price	GZ	GW	Price
02	Chrome	M766B002002	M766B004002	19 zł	M766B001002	M766B003002	23 zł
03	Satin	M766B002003	M766B004003	22 zł	M766B001003	M766B003003	35 zł
04	Gold	M766B002004	M766B004004	20 zł	M766B001004	M766B003004	30 zł
05	Structural graphite	M766B002005	M766B004005	20 zł	M766B001005	M766B003005	30 zł
06	White	M766B002006	M766B004006	19 zł	M766B001006	M766B003006	23 zł
07	Glossy anth./Graph.	M766B002007	M766B004007	20 zł	M766B001007	M766B003007	30 zł
08	Nickel-grinded	M766B002008	M766B004008	22 zł	M766B001008	M766B003008	35 zł
09	Sand structural	M766B002009	M766B004009	20 zł	M766B001009	M766B003009	30 zł
10	Piaskowy ciemny str	M766B002010	M766B004010	20 zł	M766B001010	M766B003010	30 zł
11	Antique brass	M766B002011	M766B004011	22 zł	M766B001011	M766B003011	35 zł
12	Metallic graphite	M766B002012	M766B004012	20 zł	M766B001012	M766B003012	30 zł
13	Glossy black	M766B002013	M766B004013	20 zł	M766B001013	M766B003013	30 zł
14	Czarny struktur.	M766B002014	M766B004014	20 zł	M766B001014	M766B003014	30 zł
15	Dark str. graphite	M766B002015	M766B004015	20 zł	M766B001015	M766B003015	30 zł
16	Bordowy struktur.	M766B002016	M766B004016	20 zł	M766B001016	M766B003016	30 zł
17	Gray metallic	M766B002017	M766B004017	20 zł	M766B001017	M766B003017	30 zł
18	Granite	M766B002018	M766B004018	20 zł	M766B001018	M766B003018	30 zł
19	Structural white	M766B002019	M766B004019	20 zł	M766B001019	M766B003019	30 zł
21	Matt white	M766B002021	M766B004021	20 zł	M766B001021	M766B003021	30 zł
24	Matt black	M766B002024	M766B004024	20 zł	M766B001024	M766B003024	30 zł

CONNECTION / CLAMPING ADAPTER GW 3/4"

The connector is intended for connection with the valve central heating system:

TWINS,
UNICO,
UNO,
TYPE V,
TYPE V ELEGANT.

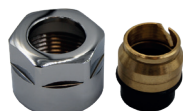

No.	Color	PEX	Cu	Price	GZ 1/2" (na kulę)	GZ 1/2" (na oring)	Price
01	Nickel	ZZ16x201	ZZM1501	9 zł	M619B006010	-	9 zł
02	Chrome	ZZ16x202	ZZM1502	19 zł	-	M869B002020	15 zł
03	Satin	ZZ16x203	ZZM1503	22 zł	M619B006030	M869B002030	27 zł
04	Gold	ZZ16x204	ZZM1504	20 zł	M619B006040	M869B002040	20 zł
05	Structural graphite	ZZ16x205	ZZM1505	20 zł	M619B006050	M869B002050	20 zł
06	White	ZZ16x206	ZZM1506	19 zł	M619B006060	M869B002060	15 zł
07	Glossy anth./Graph.	ZZ16x207	ZZM1507	20 zł	M619B006070	M869B002070	20 zł
08	Nickel-grinded	ZZ16x208	ZZM1508	22 zł	-	M869B002080	27 zł
09	Sand structural	ZZ16x209	ZZM1509	20 zł	M619B006090	M869B002090	20 zł
10	Dark sand structural	ZZ16x210	ZZM1510	20 zł	M619B006100	M869B002100	20 zł
11	Antique brass	ZZ16x211	ZZM1511	22 zł	M619B006110	M869B002110	27 zł
12	Metallic graphite	ZZ16x212	ZZM1512	20 zł	M619B006120	M869B002120	20 zł
13	Glossy black	ZZ16x213	ZZM1513	20 zł	M619B006130	M869B002130	20 zł
14	Structural black	ZZ16x214	ZZM1514	20 zł	M619B006140	M869B002140	20 zł
15	Dark str. graphite	ZZ16x215	ZZM1515	20 zł	M619B006150	M869B002150	20 zł
16	Structural maroon	ZZ16x216	ZZM1516	20 zł	M619B006160	M869B002160	20 zł
17	Gray metallic	ZZ16x217	ZZM1517	20 zł	M619B006170	M869B002170	20 zł
18	Granite	ZZ16x218	ZZM1518	20 zł	M619B006180	M869B002180	20 zł
19	Structural white	ZZ16x219	ZZM1519	20 zł	M619B006190	M869B002190	20 zł
21	Matt white	ZZ16x221	ZZM1521	20 zł	M619B006210	M869B002210	20 zł
24	Matt black	ZZ16x224	ZZM1524	20 zł	M619B006240	M869B002240	20 zł

CONNECTION ACCESSORIES

SCREWED CONNECTION GZ 1/2" x PEX 16x2 or Cu 15x1

Color	PEX	Cu	Price
Nickel	R187MX048-01	118500045/01	12 zł
Chrome	R187MX048-02	118500045/02	24 zł
Satin	R187MX048-03	118500045/03	35 zł
Gold	R187MX048-04	118500045/04	30 zł
Structural graphite	R187MX048-05	118500045/05	30 zł
White	R187MX048-06	118500045/06	24 zł
Glossy anth./Graph.	R187MX048-07	118500045/07	30 zł
Nickel-grinded	R187MX048-08	118500045/08	35 zł
Sand structural	R187MX048-09	118500045/09	30 zł
Dark sand structural	R187MX048-10	118500045/10	30 zł
Antique brass	R187MX048-11	118500045/11	35 zł
Metallic graphite	R187MX048-12	118500045/12	30 zł
Glossy black	R187MX048-13	118500045/13	30 zł
Structural black	R187MX048-14	118500045/14	30 zł
Dark str. graphite	R187MX048-15	118500045/15	30 zł
Structural maroon	R187MX048-16	118500045/16	30 zł
Gray metallic	R187MX048-17	118500045/17	30 zł
Granite	R187MX048-18	118500045/18	30 zł
Structural white	R187MX048-19	118500045/19	30 zł
Matt white	R187MX048-21	118500045/21	30 zł
Matt black	R187MX048-24	118500045/24	30 zł

Screwed connection external thread 1/2" x PEX (16x2) or Cu (15x1).

Adapted to valves:

AXI ELEGANT,
BALL,
ELEGANT,
MASTER,
ROYAL,
SWING.



NUT COUPLING 1"

Color	Catalog number	Price
Nickel	M621C015200	8 zł
Surowy	M621C016300	8 zł



TRANSITIONAL CONNECTOR

Color	Catalog number	Price
Nickel	000M806A002	20 zł

Adapter 15mm x external thread 1/2". The nipple allows a safe transition from brass to thread GZ 1/2".



REDUCING NIPPLE

Color	Catalog number	Price
Surowy	000M804A001	6 zł
Chrome	000M804A002	8 zł

Reducing nipple 1/2" x 3/4".

Designed for valves:
TWINS,
UNICO,
UNO,
TYPE V,
TYPE V ELEGANT.



CONNECTION ACCESSORIES

FLEXIBLE COVERING SLEEVE



Color	Catalog number	Price
Chrome	7990700	20 zł
White	7990690	20 zł

Flexible masking sleeve for PEX or Cu tubes with a length of 60 mm. The flexible masking sleeve allows aesthetic covering of the installation pipes (PEX or Cu) between the wall and the radiator. The design of the sleeve allows its assembly after connecting the heater to the installation.

SCREW



Color	Version	Catalog number	Price
Nickel	1/2"	M619C020200	19 zł
Nickel	3/4"	M621C017200	19 zł
Nickel	3/8"	M617C017200	19 zł

Telescopic screw connection comes in three configurations: 1/2", 3/4" or 3/8".

T-PIECE FOR AN ELECTRIC HEATER



T-piece for electric heater with internal thread 1/2" x external thread 1/2" x external thread 1/2".

TR1/202	Chrome	34 zł	TR1/212	Metallic graphite	39 zł
TR1/203	Satin	46 zł	TR1/213	Glossy black	39 zł
TR1/204	Gold	39 zł	TR1/214	Structural black	39 zł
TR1/205	Structural graphite	39 zł	TR1/215	Dark str. graphite	39 zł
TR1/206	White	34 zł	TR1/216	Structural maroon	39 zł
TR1/207	Antracyt / Grafit blysz.	39 zł	TR1/217	Gray metallic	39 zł
TR1/208	Nickel-grinded	46 zł	TR1/218	Granite	39 zł
TR1/209	Sand structural	39 zł	TR1/219	Structural white	39 zł
TR1/210	Dark sand structural	39 zł	TR1/221	Matt white	39 zł
TR1/211	Antique brass	46 zł	TR1/224	Matt black	39 zł

BATHROOM HEATER



Electric bathroom heater for bathroom radiators, used in the summer to heat the radiator and use it as a dryer.

Color	Power	Catalog number	Price
Chrome	300 WATT	GVT300W/02	358 zł
Chrome	400 WATT	GVT400W/02	358 zł
Chrome	600 WATT	GVT600W/02	358 zł
Satin	300 WATT	GVT300W/03	342 zł
Satin	400 WATT	GVT400W/03	342 zł
Satin	600 WATT	GVT600W/03	342 zł
White	300 WATT	GVT300W/06	316 zł
White	400 WATT	GVT400W/06	316 zł
White	600 WATT	GVT600W/06	316 zł
Black	300 WATT	GVT300W/14	342 zł
Black	400 WATT	GVT400W/14	342 zł
Black	600 WATT	GVT600W/14	342 zł

CONNECTION ACCESSORIES

MOUNTING TEMPLATE

19992040

9 zł

Mounting template for PEX installation base. It facilitates the location of installation bases to a specific width. It is especially useful when installing connectors with a spacing of 50 mm.



BASE FOR INSTALLATION

8990680

21 zł

Base to be mounted in a PEX installation (16x2). For Alu Pex pipes (16x2), it has a built-in brass elbow, thanks to which we can safely route Alupex pipes at right angles.



CENTER TUBE

7199998

25 zł

Centric tube external thread $\frac{1}{2}$ " x $\varnothing 15$ x 150, adapted to connect valves with a central heating installation, having an output a internal thread $\frac{1}{2}$ ".

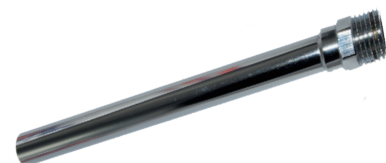

ECCENTRIC TUBE

7190290

41 zł

Eccentric tube external thread $\frac{1}{2}$ " x $\varnothing 15$ x 150 adapted to connect valves with a central heating installation, having an output a internal thread $\frac{1}{2}$ ". The tube has the ability to adjust the centricity in the 7.5 mm range to one side between the installation and the radiator.

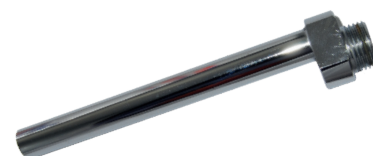

VALVE SETTING RING

M619C016100

Material



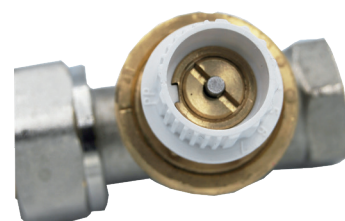

3 zł

The valve setting ring is used for thermostatic valves:

MASTER,
SFK,
SFP.

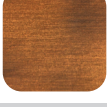

COLOR TABLE

#color	GALVANIC COVERINGS
02	CHROME 
03	SATIN 
08	NICKEL-GRIDED 
11	ANTIQUÉ BRASS 
22	SHINY GALVANIC GOLD 

Color markings:

#color means the color number

Designation for Elegant, Exclusive and RTL sets:

Sample catalog number for the Premium Exclusive angular set using the color numbering Nickel-Grinded (**08** - color number in the table):

PREGS0208C/FK

Designation for Prestige heads, valves, connection accessories:

Sample catalog number for the LUX Thermostatic valve in the right version using the Satin color numbering (**03** - color number in the table):

000M764A003

For **non-standard** color versions, there is an additional payment to the catalog price. Details from the Export Department.

#color	POWDER PAINTING
04	GOLD RAL1036 
05	STRUCTURAL GRAPHITE 
06	WHITE RAL9003 
07	ANTHRACITE/ GLOSSY GRAPHITE RAL7016 
09	SAND STRUCTURAL 
10	DARK SAND STRUCTURAL 
12	METALLIC GRAPHITE 
13	GLOSSY BLACK RAL9005 
14	STRUCTURAL BLACK RAL9005 
15	DARK STR. GRAPHITE 
16	STRUCTURAL MAROON 
17	GRAY METALLIC 
18	GRANITE 
19	STRUCTURAL WHITE 
21	MATT WHITE RAL9003 
24	MATT BLACK RAL9005 

LEGEND

P - right K - angle
L - left P - straight
A - axial

TABLE OF CONTENTS

CHAPTER	PRODUCT	PAGE
PONY thermostatic heads	GS.10	4
TRENDY thermostatic heads	GS.05, GS.06, GS.07, GS.08, GHe.02	6
VENUS thermostatic heads	GS.09: VENUS I, VENUS II	8
PICCO thermostatic heads	GS.02, GS.03, GS.04	10
PRESTIGE thermostatic heads	GS.02, GS.03, GS.04, GHe.01	14
TUCAN thermostatic heads	GS.10	20
CONTACT thermostatic head	with contact sensor	22
DISTANT thermostatic head	with remote sensor	23
THERMOSTATIC valves		26
ECONOMIC sets	ECON, SWING II, SIMPLE, ARCUS, AXI ECONOMIC	28
STANDARD sets	STANDARD, MASTER, VERSO, UNO, TYPE V	30
ELEGANT sets	TYPE V ELEGANT	35
ELEGANT sets	BALL	36
ELEGANT sets	SWING	37
ELEGANT sets	AXI ELEGANT	38
ELEGANT sets	MASTER	39
ELEGANT sets	ELEGANT	40
ELEGANT sets	ROYAL	41
EXCLUSIVE sets	TWINS	43
EXCLUSIVE sets	TWINS regulating	44
EXCLUSIVE sets	TWINS shut-off	45
EXCLUSIVE sets	UNICO	46
EXCLUSIVE sets	UNICO regulating	47
EXCLUSIVE sets	VISION	48
EXCLUSIVE sets	VISION regulating	49
EXCLUSIVE sets	INTEGRA	50
EXCLUSIVE sets	INTEGRA regulating	51
EXCLUSIVE sets	QUATTRO	52
EXCLUSIVE sets	QUATTRO regulating	53
EXCLUSIVE sets	LUX I	54
EXCLUSIVE sets	LUX II	55
EXCLUSIVE sets	PREMIUM EXCLUSIVE	56
All In One sets	ALL IN ONE GLAMOUR	57
Floor heating		58
RTL sets	STANDARD RTL, LIMIT BOX	59
RTL sets	TWINS RTL, UNICO RTL	60
RTL sets	VISION RTL, LUX II RTL	61
System VRC	VRC set, central, VRC therm. head, temp. and humidity sensor	64
Masking accessories	Rosette masking and masking sets	66
Connection accessories	Extension	69
Connection accessories	Connections, nipples	70
Connection accessories	Various	72



Products

Thermostatic heads

Thermostatic valves

Thermostatic sets for heaters

Accessories and connection fittings

Vario Term sp. z o.o.

Ogórkowa 96, 04-998 Warsaw, Poland

tel. +48 22 872 42 14

info@varieterm.pl

www.varieterm.pl/en

